

TPG 361, TPG 362

SingleGauge, DualGauge

Single- and Dual-Channel Measurement and Control Unit for ActiveLine Transmitter

Operating Instructions

Product Identification

In all communications with Pfeiffer Vacuum, please specify the information on the product nameplate.

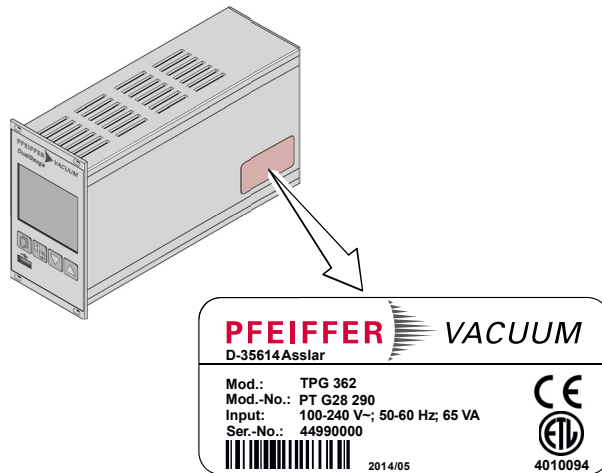

Specimen nameplate

Validity

This document applies to products with part numbers:

PT G28 040 (TPG 361, SingleGauge)
 PT G28 290 (TPG 362, DualGauge)

The part number (Mod.-No.) can be found on the product nameplate.

This manual is based on firmware version V010100.

If your unit does not work as described in this document, please check that it is equipped with the above firmware version (→ 45).

If not indicated otherwise in the legends, the illustrations in this document correspond to the unit TPG 362 (DualGauge). They apply to TPG 361 (SingleGauge) by analogy.

We reserve the right to make technical changes without prior notice.

All dimensions are indicated in mm.

Intended Use

The TPG 361 and TPG 362 are used together with Pfeiffer Vacuum ActiveLine transmitter (in this document referred to as gauges) for total pressure measurement. All products must be operated in accordance with their respective Operating Instructions.

Scope of Delivery

The scope of delivery consists of the following parts:



- 1 Control Unit
- 1 Power cord
- 1 Connector for *control* connection
- 4 Collar screws and plastic sleeves
- 2 Rubber feet
- 1 Rubber bar
- 1 Installation Instructions
- 3 Operating Instructions (1×de, 1×en, 1×fr)

Trademark

FullRange® Pfeiffer Vacuum GmbH

Contents

Product Identification	2
Validity	2
Intended Use	3
Scope of Delivery	3
Trademark	3
1 Safety	5
1.1 Symbols Used	5
1.2 Personnel Qualifications	5
1.3 General Safety Instructions	6
1.4 Liability and Warranty	6
2 Technical Data	7
3 Installation	11
3.1 Personnel	11
3.2 Installation, Setup	11
3.2.1 Rack Installation	11
3.2.2 Installation in a control panel	12
3.2.3 Use as Desk-Top Unit	13
3.3 Mains Power Connector	14
3.4 Gauge Connectors <i>sensor 1, sensor 2</i>	14
3.5 <i>Control</i> Connector	15
3.6 <i>Relay</i> Connector	16
3.7 Interface Connector <i>RS485</i>	17
3.8 Interface Connector USB Type B	17
3.9 Interface Connector USB Type A	17
3.10 Interface Connector Ethernet	18
4 Operation	19
4.1 Front panel	19
4.2 Turning the TPG 36x On and Off	20
4.3 Operating Modes	21
4.4 Measurement Mode	22
4.5 Parameter Mode	24
4.5.1 Switching Function Parameters	25
4.5.2 Gauge parameters	27
4.5.3 Gauge Control	34
4.5.4 General Parameters	39
4.5.5 Test Parameters	45
4.6 Data Logger Mode	48
4.7 Setup Mode	50
5 Maintenance	53
6 Troubleshooting	54
7 Repair	55
8 Storage	55
9 Disposal	55
Appendix	56
A: ConversionTables	56
B: Firmware Update	57
C: Ethernet Configuration	60
D: Literature	62
ETL Certification	64
EC Declaration of Conformity	65

For cross-references within this document, the symbol (→  XY) is used; for cross-references to further documents listed under 'Literature', use is made of the symbol (→  [Z]).

1 Safety

1.1 Symbols Used

Symbols for residual risks



Information on preventing any kind of physical injury.



Information on preventing extensive equipment and environmental damage.



Information on correct handling or use. Disregard can lead to malfunctions or minor equipment damage.

Further symbols



The lamp / display is lit.



The lamp / display flashes.



The lamp / display is dark.



Press the key (example: PARA key).



Do not press any key.



Labeling

1.2 Personnel Qualifications



Skilled personnel

All work described in this document may only be carried out by persons who have suitable technical training and the necessary experience or who have been instructed by the end-user of the product.

1.3 General Safety Instructions

Adhere to the applicable regulations and take the necessary precautions for all work you are going to do and consider the safety instructions in this document.

STOP
DANGER



DANGER: mains voltage
 Contact with live parts is extremely hazardous when any objects are introduced or any liquids penetrate into the unit.
 Make sure no objects enter through the louvers and no liquids penetrate into the equipment.



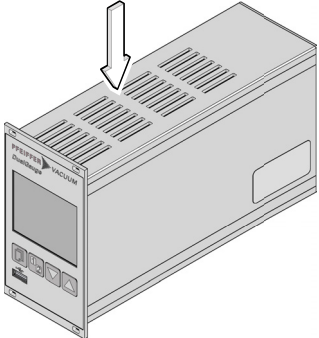

Disconnecting device

The disconnecting device must be readily identifiable by and easily reached by the user.

To disconnect the unit from the mains supply, you must unplug the mains cable.

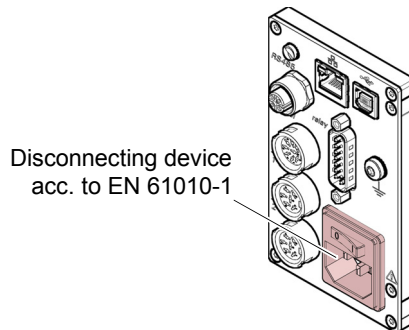

Communicate the safety instructions to all other users.







1.4 Liability and Warranty

Pfeiffer Vacuum assumes no liability and the warranty is rendered null and void if the end-user or third parties

- disregard the information in this document
- use the product in a non-conforming manner
- make any kind of interventions (modifications, alterations etc.) on the product
- use the product with accessories not listed in the corresponding product documentation.

2 Technical Data

Mains specifications	Voltage	100 ... 240 VAC \pm 10%
	Frequency	50 ... 60 Hz
	Power consumption	
	TPG 361	\leq 45 VA
	TPG 362	\leq 65 VA
	Overvoltage category	II
	Protection class	1
Connection	European appliance connector IEC 320 C14	
Ambience	Temperature	
	storage	-20 ... +60 °C
	operation	+ 5 ... +50 °C
	Relative humidity	\leq 80% up to +31 °C, decreasing to 50% at +40 °C
	Use	indoors only max. altitude 2000 m NN
	Pollution degree	II
Pollution type	IP20	
Gauge connections	Number	
	TPG 361	1
	TPG 362	2 (1 per channel)
<i>sensor connector</i>	Amphenol C91B appliance connector, 6-pin, (pin assignment → 15)	
Compatible compact gauges		
Pirani	TPR 261, TPR 265, TPR 280, TPR 281	
Pirani Capacitance	PCR 260, PCR 280	
Cold Cathode	IKR 251, IKR 261, IKR 270, IKR 360, IKR 361	
FullRange® CC	PKR 251, PKR 261, PKR 360, PKR 361	
Process Ion	IMR 265	
FullRange® BA	PBR 260	
Capacitance	CMR 261 ... CMR 275, CMR 361 ... CMR 375	
Piezo	APR 250 ... APR 267	
Gauge supply	Voltage	+24 VDC \pm 5%
	Ripple	\leq 1%
	Current	0 ... 1 A (per channel)
	Power	25 W (per channel)
	Fuse protection	1.5 A (per channel) with PTC element, self- resetting after turning the unit off or disconnect- ing the gauge. The supply conforms to the grounded protective extra low voltage require- ments.
	Operation	Front panel
TPG 361		via 3 keys
TPG 362		via 4 keys
Remote control		via RS485 interface via USB type B interface via ethernet interface

Measurement values	Measurement ranges	depending on gauges (→  [1] ... [18])
	Measurement error	
	gain error	≤0.01% F.S. (typical) ≤0.10% F.S. (over temperature range, time)
	offset error	≤0.01% F.S. (typical) ≤0.10% F.S. (over temperature range, time)
	Measurement rate analog	≥100 / s
	Display rate	≥10 / s
	Filter time constant	
	slow	750 ms ($f_g = 0.2$ Hz)
	normal	150 ms ($f_g = 1$ Hz)
	fast	20 ms ($f_g = 8$ Hz)
	Measurement units	mBar, hPa, Torr, Pa, Micron, V
	Offset correction	for linear gauges -5 ... 110% F.S.
	Calibration factor	0.10 ... 10.00
A/D converter	resolution 0.001% F.S.	
Switching functions	Number	
	TPG 361	2
	TPG 362	4 (user-assignable)
	Reaction delay	≤10 ms, if switching threshold close to measurement value (for larger differences consider filter time constant).
	Adjustment range	depending on gauge (→  [1] ... [18])
Hysteresis	≥1% F.S. for linear gauges, ≥10% of measurement value for logarithmic gauges	
Switching function relays	Contact type	floating changeover contact
	Load max.	60 V(dc), 30 W (ohmic) 30 V(ac), 1 A (ohmic)
	Service life	
	mechanical	1×10^8 cycles
	electrical	1×10^5 cycles (at max. load)
	Contact positions	→  16
Relay connector	D-Sub appliance connector, female, 15-pin (pin assignment →  16)	
Error signal	Number	1
	Reaction time	≤10 ms
Error signal relay	Contact type	floating normally open contact
	Load max.	60 V(dc), 0.5 A, 30 W (ohmic) 30 V(ac), 1 A (ohmic)
	Service life	
	mechanical	1×10^8 cycles
	electrical	1×10^5 cycles (at max. load)
	Contact positions	→  15
Control connector	Amphenol C91B appliance connector, female, 7-pin (pin assignment →  15)	

Gauge control	Automatic	
	ON setpoint	adjustable (→ 13 36)
	OFF setpoint	adjustable (→ 13 38)
	Manual	
	via keys	
	activation/deactivation	→ 13 22
	External	
	via <i>control</i> connector	
	ON condition	Signal $\leq +0.8$ V(dc)
	OFF condition	Signal +2.0 ... 5 V(dc) or input open
Hotstart		
when mains power on	→ 13 36	
Self control		
deactivation when pressure is rising OFF threshold	adjustable (→ 13 38)	
<i>Control</i> connector	Amphenol C91B appliance connector, female, 7-pin (pin assignment → 13 15)	
Analog outputs	Number	
	TPG 361	1
	TPG 362	2 (1 per channel)
	Voltage range	0 ... +10 V(dc)
	Deviation from display value	± 10 mV
	Output resistance	$< 50 \Omega$
	Measuring signal vs. pressure	depending on gauge (→ 13 [1] ... [18])
	<i>Control</i> connector	Amphenol C91B appliance connector, female, 7-pin (pin assignment → 13 15)
RS485 interface	Protocol	<ul style="list-style-type: none"> • ACK/NAK, ASCII with 3-character mnemonics, or • PV protocol
	Data format	bi-directional data flow, 1 start bit, 8 data bits, 1 stop bit, no parity bit, no handshake
	Transmission rate	9600
	<i>RS485</i> connector	Binder M12 appliance connector, 5-pin (pin assignment → 13 17)
USB Type A interface	Protocol	FAT file system file handling in ASCII format
USB Type B interface	Protocol	<ul style="list-style-type: none"> • ACK/NAK, ASCII with 3-character mnemonics, or • PV protocol
	Data format	bi-directional data flow, 1 start bit, 8 data bits, 1 stop bit, no parity bit, no handshake
	Transmission rate	9600, 19200, 38400, 57600, 115200
Ethernet interface	Protocol	<ul style="list-style-type: none"> • ACK/NAK, ASCII with 3-character mnemonics, or • PV protocol
	Data format	bi-directional, 1 start bit, 8 data bits, 1 stop bit, no parity bit, no handshake
	Transmission rate	9600, 19200, 38400, 57600, 115200
	IP Address	DHCP (default) or manual setting (→ 13 60)
	MAC Address	readable via "MAC" parameter

Dimensions [mm]

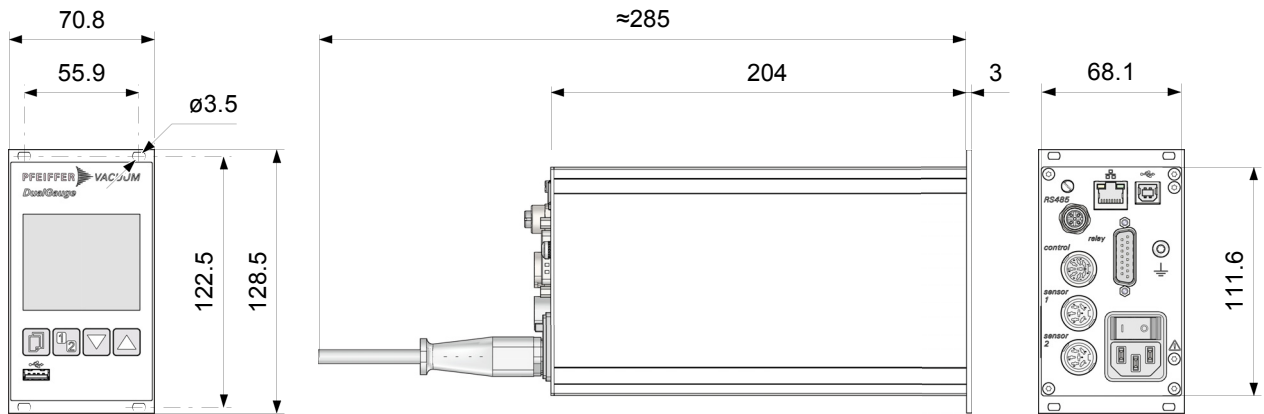

Use

For incorporation into a rack or control panel or as a desk-top unit

Weight

1.1 kg

3 Installation

3.1 Personnel



Skilled personnel

The unit may only be installed by persons who have suitable technical training and the necessary experience or who have been instructed by the end-user of the product.

3.2 Installation, Setup

The unit is suited for incorporation into a 19" rack or a control panel or for use as a desk-top unit.



DANGER

Putting a product which is visibly damaged into operation can be extremely hazardous. If the product is visibly damaged do not put it into operation and make sure it is not inadvertently put into operation.

3.2.1 Rack Installation

The unit is designed for installation into a 19" rack chassis adapter according to DIN 41 494. For this purpose, four collar screws and plastic sleeves are supplied with it.



DANGER

DANGER: protection class of the rack

If the product is installed in a rack, it is likely to lower the protection class of the rack (protection against foreign bodies and water) e.g. according to the EN 60204-1 regulations for switching cabinets.

Take appropriate measures for the rack to meet the specifications of the protection class.

Guide rail

In order to reduce the mechanical strain on the front panel of the TPG 36x, preferably equip the rack chassis adapter with a guide rail.

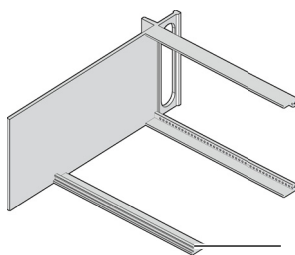

Guide rail

Height 3 rack chassis adapter

- 1 Secure the rack adapter in the rack frame.



The maximum admissible ambient temperature (→ 7) must not be exceeded and the air circulation must not be obstructed.

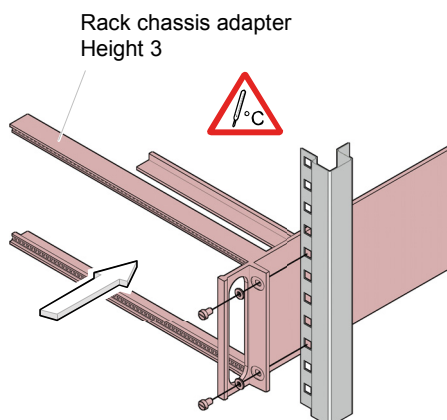

- 2 Slide the TPG 36x into the rack chassis adapter ...

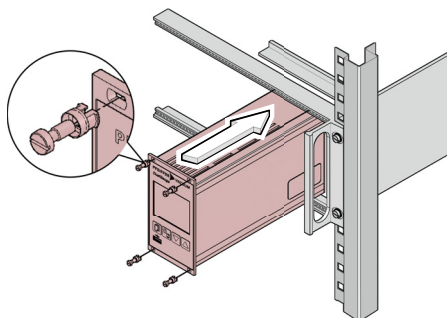

... and fasten the adapter panel to the rack chassis adapter using the screws supplied with the TPG 36x.

3.2.2 Installation in a control panel

STOP DANGER



DANGER: protection class of the rack

If the product is installed in a rack, it is likely to lower the protection class of the rack (protection against foreign bodies and water) e.g. according to the EN 60204-1 regulations for switching cabinets.

Take appropriate measures for the rack to meet the specifications of the protection class.

For mounting the TPG 36x into a control panel, the following cut-out is required:

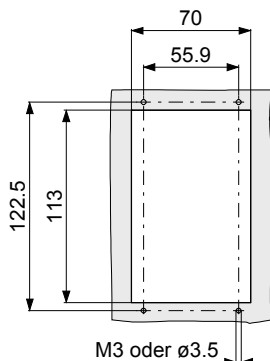

The maximum admissible ambient temperature (→ 7) must not be exceeded and the air circulation must not be obstructed.

For reducing the mechanical strain on the front panel of the TPG 36x, preferably support the unit.

- 1 Slide the TPG 36x into the cut-out of the control panel ...

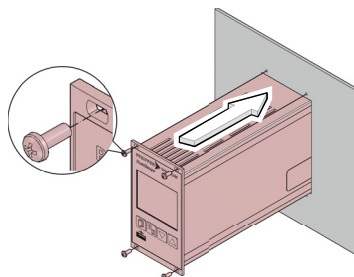

... and secure it with four M3 or equivalent screws.

3.2.3 Use as Desk-Top Unit

The TPG 36x may also be used as a desk-top unit. For this purpose, two self-adhesive rubber feet and a slip-on rubber bar are supplied with it.

- 1 Stick the two supplied rubber feet to the rear part of the bottom plate ...

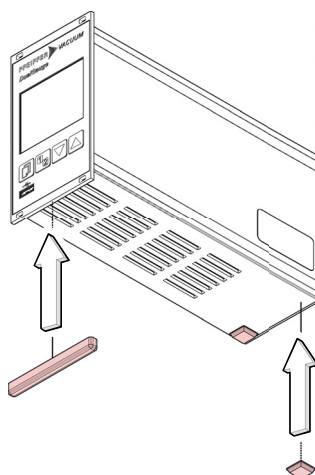

... and slip the supplied rubber bar onto the bottom edge of the front panel.



Select a location where the admissible maximum ambient temperature (→ 7) is not exceeded (e.g. due to sun irradiation).

3.3 Mains Power Connector

DANGER

DANGER: line voltage
 Incorrectly grounded products can be extremely hazardous in the event of a fault.

Use only a 3-conductor power cable with protective ground. The mains power connector may only be plugged into a socket with a protective ground. The protection must not be nullified by an extension cable without protective ground.

The unit is supplied with a power cord. If the mains connector is not compatible with your system, use your own, suitable cable with protective ground (3×1.5 mm³).

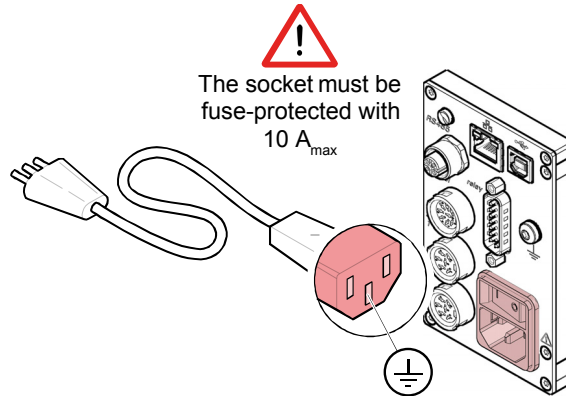

If the unit is installed in a switching cabinet, the mains voltage should be supplied and turned on via a central distributor.

Ground Connection

On the rear of the unit is a screw enabling the TPG 36x where necessary to be connected via a ground conductor, e.g. with the protective ground of the pump stand.



3.4 Gauge Connectors *sensor 1, sensor 2*



Gauge connector *sensor 2* is not present in TPG 361.

For each measurement channel, there is a female appliance connector on the rear of the unit.



Connect the gauge to the *sensor* connector via a sensor cable set available from us (→ sales literature) or your own, screened (electromagnetic compatibility) sensor cable. Use compatible gauges only (→ 7).

Pin assignment
sensor 1, sensor 2



Gauge connector sensor 2 is not present in TPG 361.

Pin assignment of the two female 6-pin Amphenol C91B appliance connectors:

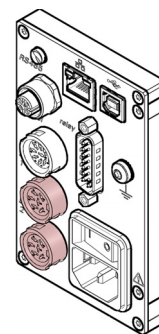
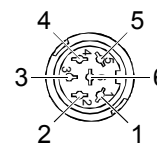

Pin	Signal
1	Identification
6	Supply +24 V(dc)
2	Supply common GND
3	Signal input (measuring signal 0 ... +10 V(dc))
4	Signal common (measuring signal-)
5	Screening

3.5 Control Connector

This connector allows the user to read the measuring signal, evaluate the state of the floating contacts of the error relay, and activate or deactivate the gauges (→ 34).



Connect the peripheral components to the *control* connector on the rear of the unit using your own, screened (electromagnetic compatibility) cable.

Pin assignment,
Contact positions
control

Pin assignment of the female 7-pin Amphenol C91B appliance connector:

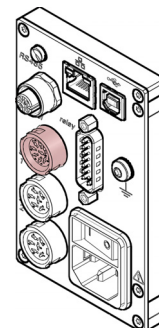
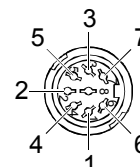

In TPG 361 Pin 1 and Pin 6 are not assigned.

Pin	Signal
2	Analog output gauge 1 0 ... +10 V(dc)
1	Analog output gauge 2 0 ... +10 V(dc)
5	Screening GND
4	Gauge 1 on: signal ≤+0.8 V(dc) off: signal +2.0 ... 5 V(dc) or input open
6	Gauge 2 on: signal ≤+0.8 V(dc) off: signal +2.0 ... 5 V(dc) or input open
3	No error Error or power supply turned off
7	

A suitable connector is supplied with the TPG 36x.

3.6 Relay Connector

This connector allows to use of the floating switching contacts for an external control system.



Connect the peripheral components to the *relay* connector on the rear of the unit using your own, screened (electromagnetic compatibility) cable.

Pin assignment,
Contact positions
relay

Pin assignment of the female 15-pin D-Sub appliance connector:

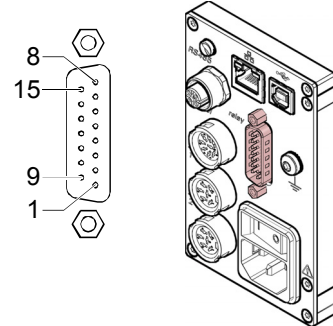

In TPG 361 Pin 9 to Pin 14 are not assigned.

Pin	Signal
Switching function 1	
4	Pressure below threshold
3	Pressure above threshold or power supply turned off
2	
Switching function 2	
7	Pressure below threshold
6	Pressure above threshold or power supply turned off
5	
Switching function 3	
11	Pressure below threshold
10	Pressure above threshold or power supply turned off
9	
Switching function 4	
14	Pressure below threshold
13	Pressure above threshold or power supply turned off
12	
Supply for relays with higher switching power	
15	+24 V(dc), 200 mA
1	GND
8	GND

Fuse-protected at 300 mA with PTC element, self-resetting after turning off the TPG 36x or pulling the *relay* connector. Meets the grounded protective extra low voltage requirements.

3.7 Interface Connector RS485

The RS485 interface allows for operating the TPG 36x via a HOST or terminal (→ [19]). Integration into a bus system is possible with the use of a Y distributor.



Connect the serial interface to the RS485 connector on the rear of the unit using a screened (electromagnetic compatibility) cable.

Pin assignment
RS485

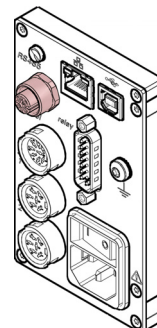
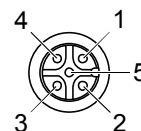

Pin assignment of the female 5-pin Binder M12 appliance connector:

Pin	Signal
1	RS485+ (differential)
2	+24 V(dc), ≤200 mA
3	GND
4	RS485- (differential)
5	not assigned

3.8 Interface Connector USB Type B

The USB Type B interface connector facilitates direct communication with the TPG 36x via a computer (e.g. firmware update, parameter saving (read/write)).



Connect the USB interface connector to the USB connector on the rear of the unit using a screened (electromagnetic compatibility) cable.

Pin assignment
USB Type B

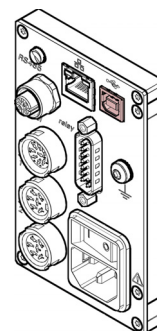
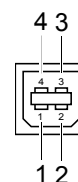

Pin assignment of the 4-pin USB Type B appliance connector:

Pin	Signal
1	VBUS (5 V)
2	D-
3	D+
4	GND

3.9 Interface Connector USB Type A

The USB Type A interface connector with master functionality is situated on the front of the unit and is used for the connection of a USB memory stick (e.g. firmware update, parameter saving (read/write), data logger).



Connect the USB memory stick to the connector on the front of the unit.

Pin assignment USB Type A

Pin assignment of the 4-pin USB Type A appliance connector:

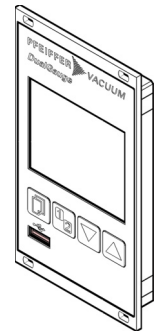
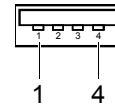

Pin	Signal
1	VBUS (5 V)
2	D-
3	D+
4	GND

3.10 Interface Connector Ethernet

The ethernet interface allows direct communication with the TPG 36x via a computer.



Connect the ethernet cable to the connector  on the rear of the unit.

Pin assignment Ethernet

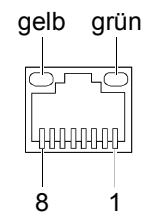

Pin assignment of the 8-pin RJ45 appliance connector:

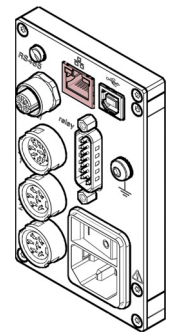

Pin	Signal
1	TD+ (transmission data +)
2	TD- (transmission data -)
3	RD+ (received data +)
4	NC
5	NC
6	RD- (received data -)
7	NC
8	NC

Green LED

Link or transmit LED. Indicates that a hardware connection has been established.

Yellow LED

Status or packet detect LED. Indicates the status of the transmission. When this LED flashes or flickers, data are being transmitted.

4 Operation

4.1 Front panel

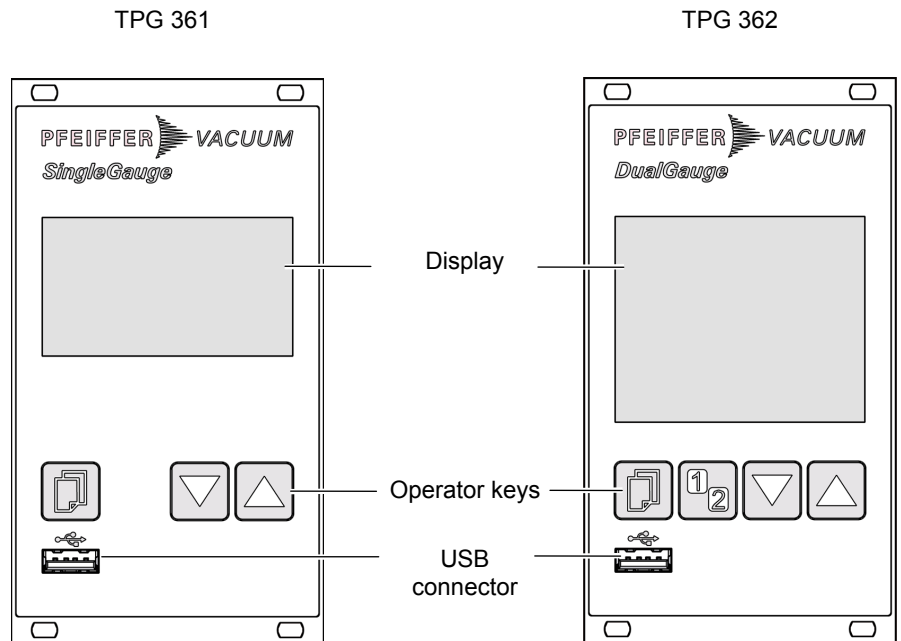

Display TPG 36x

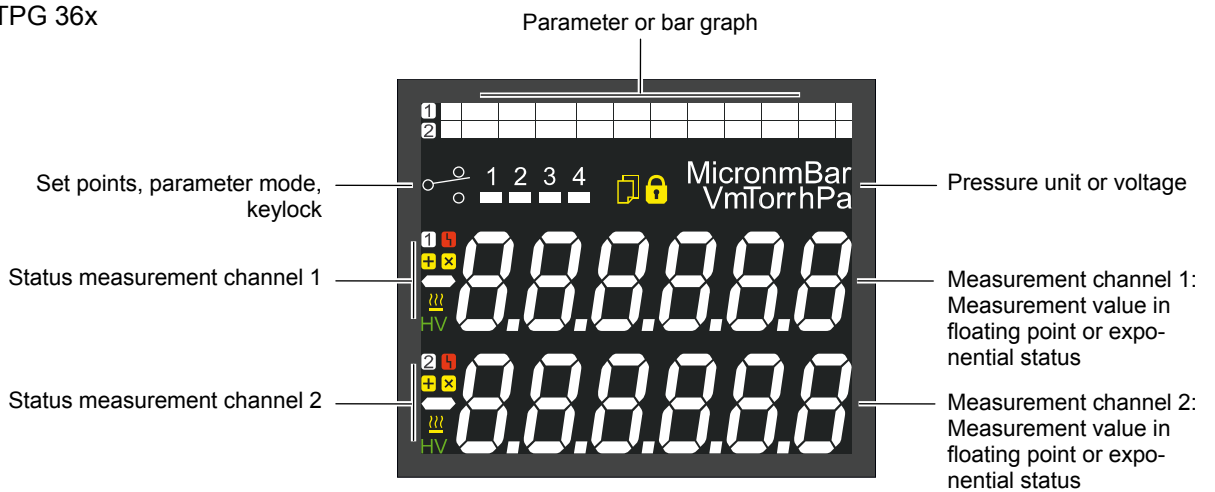

Parameter, bar graph

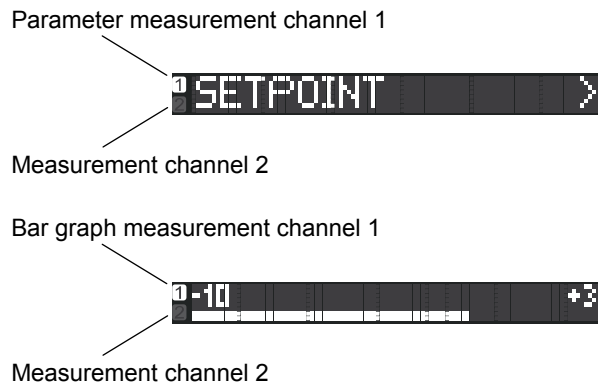

Bar graph with set point measurement channel 1



Measurement channel 2

Pressure vs. time, trend measurement channel 1



Measurement channel 2

Set points, parameter mode, keylock

Set points 1 ... 4



Relay on

Relay off

Parameter mode activated



Keylock on

Measurement channel specifically

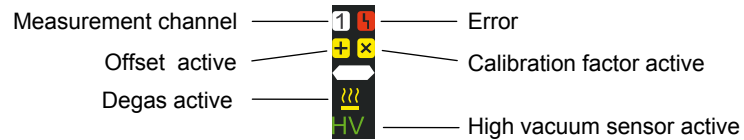

4.2 Turning the TPG 36x On and Off

Make sure the unit is correctly installed and the specifications in the Technical Data are met.

Turning the TPG 36x on

The power switch is on the rear of the unit.

Turn the TPG 36x on with the power switch (or centrally, via a switched power distributor, if the unit is incorporated in a rack).

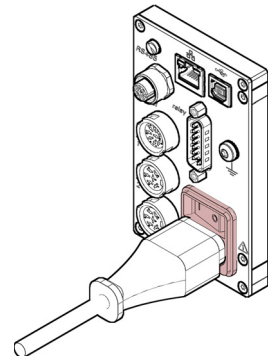

After power on, the TPG 36x ...

- automatically performs a self-test
- identifies the connected gauges
- activates the parameters that were in effect before the last power off
- switches to the Measurement mode
- adapts the parameters if required (if a different gauge was previously connected).

Turning the TPG 36x off

Turn the TPG 36x off with the power switch (or centrally, via a switched power distributor, if the unit is incorporated in a rack).



Wait at least 10 s before turning the TPG 36x on again in order for it to correctly initialize itself.

4.3 Operating Modes

The TPG 36x works in the following operating modes:

- Measurement mode
for displaying measurement values or statuses (→ 22)
- Parameter mode
for displaying and editing parameters (→ 24)
 - Switching function parameter group **SETPOINT** >
 - for entering and displaying thresholds (→ 25)
 - Gauge parameter group **SENSOR** >
 - for entering and displaying gauge parameters (→ 27)
 - Gauge control group **SENSOR-CONTROL** >
 - for entering and displaying gauge control parameters (→ 34)
 - General parameter group **GENERAL** >
 - for entering and displaying general parameters (→ 39)
 - Test program group **TEST** >
 - for running internal test programs (→ 45)
- Data logger mode **DATA LOGGER** >
- for logging measurement data (→ 48)
- Program transfer mode **SETUP** >
- for saving (read/write) parameters (→ 50)

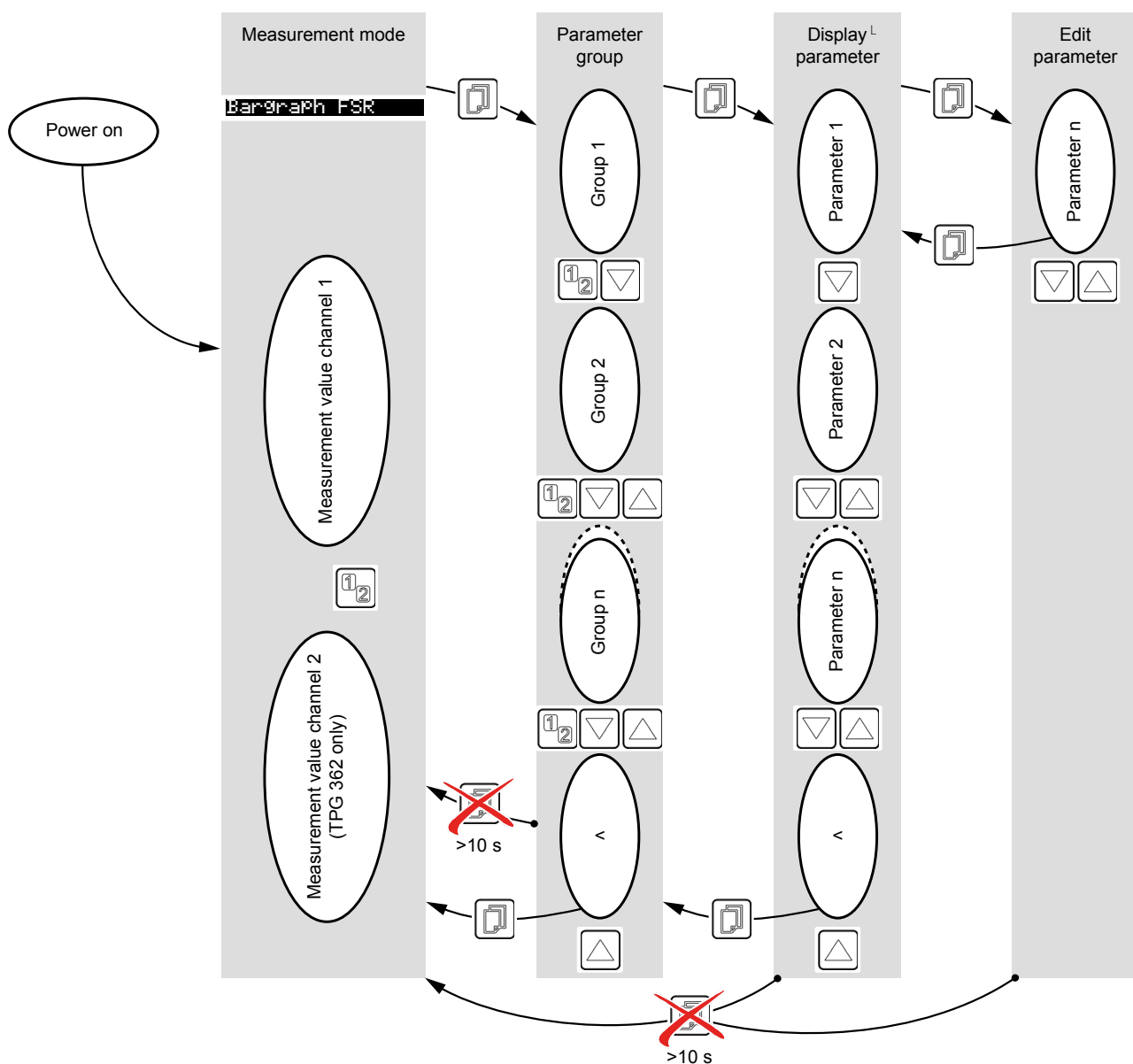

4.4 Measurement Mode

Measurement mode is the standard operating mode of the TPG 36x with display of

- a bar graph (if required)
- a measurement value for each measurement channel
- status messages for each measurement channel

Adjusting bar graph

If required a bar graph may be displayed (→ 42).

Changing measurement channel (TPG 362 only)



The unit alternates between measurement channels one and two. The number of the selected measurement channel lights up.

Turning the gauge on/off

Certain gauges can be turned on and off manually, provided the gauge control is set to **S-ON HAND** (→ 34).

Available for the following gauges:

- | | | |
|-------------------------------------|--------------------------|-------|
| <input type="checkbox"/> | Pirani Gauge | (TPR) |
| <input type="checkbox"/> | Pirani Capacitance Gauge | (PCR) |
| <input checked="" type="checkbox"/> | Cold Cathode Gauge | (IKR) |
| <input checked="" type="checkbox"/> | FullRange® CC Gauge | (PKR) |
| <input checked="" type="checkbox"/> | Process Ion Gauge | (IMR) |
| <input checked="" type="checkbox"/> | FullRange® BA Gauge | (PBR) |
| <input type="checkbox"/> | Capacitance Gauge | (CMR) |
| <input type="checkbox"/> | Piezo Gauge | (APR) |

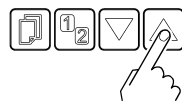

⇒ Press key for >1 s:
Gauge switches off. Instead of a measurement value the word OFF is displayed.



⇒ Press key for >1 s:
Gauges switches on. Instead of the measurement value a status message may be displayed:

Measurement range

If the unit is operated with linear gauges (CMR 261 ... 375, APR 250 ... 267), negative pressures may be indicated.

Possible causes:

- negative drift
- activated offset correction.

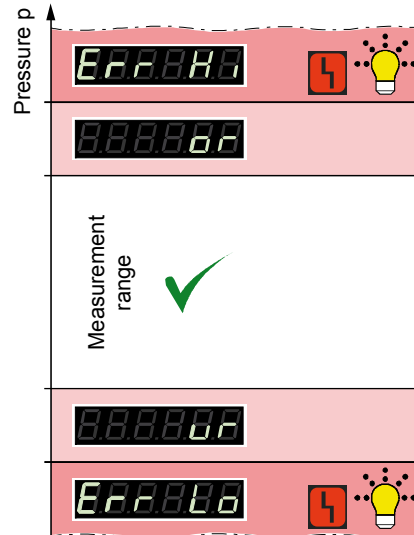

Displaying the gauge identification

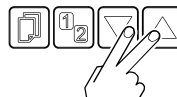

⇒ Press keys for >0.5 ... 1 s:
For the measurement channel in question the type of the connected gauge is automatically identified and displayed for 4 s:

Pirani Gauge (TPR 261, TPR 265, TPR 280, TPR 281)	}	Sx TPR/PCR
Pirani Capacitance Gauge (PCR 260, PCR 280)		
Cold Cathode Gauge (IKR 251, IKR 261, IKR 270, IKR 360, IKR 361)		Sx IKR
FullRange® CC Gauge (PKR 251, PKR 261, PKR 360, PKR 361)		Sx PKR
Process Ion Gauge (IMR 265)		Sx IMR
FullRange® BA Gauge (PBR 260)		Sx PBR
Capacitance Gauge (CMR 261 ... CMR 375)	}	Sx CMR/APR
Piezo Gauge (APR 250 ... APR 267)		
No gauge connected		Sx noSENSOR
Gauge connected, but not identifiable		Sx noIDENT

Changing to the Parameter mode

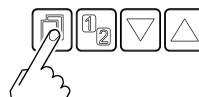

→ 24

4.5 Parameter Mode

The Parameter mode is used for displaying, editing and entering parameter values as well as for testing the TPG 36x and for saving measurement data. For ease of operation the individual parameters are divided into groups.

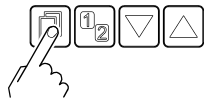

Unit switches from measurement mode to parameter mode. The respective parameter group is displayed in place of the bar graph.



Selecting a parameter group

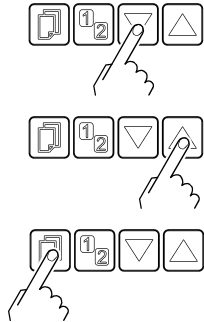

Select group

Confirm group

- ⇒ Switching function parameters → 25
- Gauge parameters → 27
- Gauge control → 34
- General parameters → 39
- Test parameters → 45
- Data logger → 48
- Program transfer → 50

Reading a parameter in a parameter group

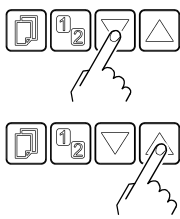

Editing and saving a parameter in a parameter group

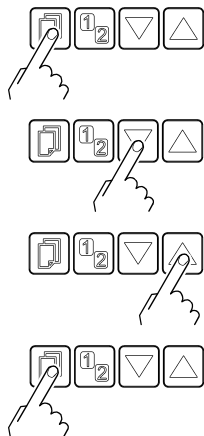

Confirm the parameter. The value flashes and can now be edited.

Edit the value.

Save the change and return to read mode

4.5.1 Switching Function Parameters

SETPOINT >

The switching function parameter group is used for displaying, editing and entering threshold values and assigning the two (TPG 361) or four (TPG 362) switching functions to a measurement channel.

Parameters in this group

SP1-CH

Assignment of switching function 1 to a channel

SP1-L

Switching function 1 lower threshold

SP1-H

Switching function 1 upper threshold

SP2-CH

Assignment of switching function 2 to a channel

SP2-L

Switching function 2 lower threshold

SP2-H

Switching function 2 upper threshold

SP3-CH

Assignment of switching function 3 to a channel (TPG 362 only)

SP3-L

Switching function 3 lower threshold (TPG 362 only)

SP3-H

Switching function 3 upper threshold (TPG 362 only)

SP4-CH

Assignment of switching function 4 to a channel (TPG 362 only)

SP4-L

Switching function 4 lower threshold (TPG 362 only)

SP4-H

Switching function 4 upper threshold (TPG 362 only)

<

One level back

The TPG 361 has two, and the TPG 362 four, switching functions with two adjustable thresholds each. The status of the switching functions is displayed on the front panel (→ 19, 15) and can be evaluated via the floating contacts at the *relay* connector.

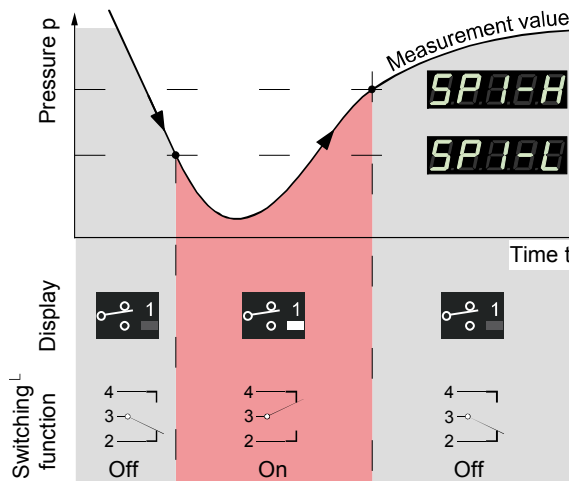

Selecting a parameter

⇒ The name of the parameter and the currently valid parameter value are displayed.
e.g.: **SP1-CH DISABLED**
Switching function 1 turned off

⇒ Select parameter. The value flashes and can now be edited.

Editing and saving the parameter

⇒ Press key for <1 s:
The value is increased/decreased by 1 increment.

Press key for >1 s:
The value is increased/decreased continuously.

⇒ Save the change and return to read mode.

We recommend setting the threshold $\frac{1}{2}$ decade above the lower, or $\frac{1}{2}$ decade below the upper, threshold limit.

Assigning a switching function

	Value
SP1-CH	Assignment of a switching function to a measurement channel.
SP1-CH 1	⇒ Switching function 1 is assigned to channel 1
SP1-CH 2	⇒ Switching function 1 is assigned to channel 2
SP1-CH DISABLED	⇒ Switching function 1 is factory-deactivated
SP1-CH ENABLED	⇒ Switching function 1 is turned on

The lower and the upper threshold of a switching function are always assigned to the same channel. The last assignment is valid for both thresholds.

Limits of the lower switching thresholds

	Value
SP1-L	The lower threshold (Setpoint low) defines the pressure at which the switching function is activated when the pressure is dropping.
e.g.: SP1-L 5.00-4	⇒ gauge dependent (→ table). If another gauge type is connected, the TPG 36x automatically adjusts the switching threshold if required.

	lower threshold limit	upper threshold limit
Sx TPR/PCR	5×10^{-4} *)	1500
Sx IKR	IKR 2x1: 1×10^{-9} IKR 36x: 1×10^{-9} IKR 270: 1×10^{-11}	1×10^{-2}
Sx PKR	1×10^{-9}	1000
Sx IMR	1×10^{-6}	1000
Sx PBR	5×10^{-10}	1000
Sx CMR/APR	F.S. / 1000	F.S

all values in hPa, GAS=nitrogen

*) 5×10^{-5} hPa, if RNE-EXT is activated (→ 40)



The minimum hysteresis between the upper and lower switching threshold amounts to at least 10% of the lower threshold or 1% of the set full scale value. The upper threshold is if necessary automatically adjusted to a minimum hysteresis. This prevents unstable states.

Limits of the upper switching thresholds

	Value
SP1-H	The upper switching threshold (Setpoint high) defines the pressure at which the switching function is deactivated when the pressure is rising.
e.g.: SP1-H 1500	⇒ Gauge dependent (→ table). If another gauge type is connected, the TPG 36x automatically adjusts the threshold if required.

	lower threshold limit	upper threshold limit
Sx TPR/PCR	+10% lower threshold	1500
Sx IKR	+10% lower threshold	1×10^{-2}
Sx PKR	+10% lower threshold	1000
Sx IMR	+10% lower threshold	1000
Sx PBR	+10% lower threshold	1000
Sx CMR/APR	+1% measurement range (F.S.)	F.S

all values in hPa, GAS=nitrogen



The minimum hysteresis between the upper and lower switching threshold amounts to at least 10% of the lower threshold or 1% of the set full scale value. This prevents unstable states.

4.5.2 Gauge parameters

SENSOR

The sensor parameter group is used for displaying, entering and editing parameters of the connected gauges.

Parameters in this group

DEGAS	Cleaning the electrode system.
FSR	Measurement range linear gauges.
FILTER	Measurement value filter.
OFFSET	Offset correction.
GAS	Calibration factor for other gases.
COR	Offset correction.
DIGITS	Display resolution.
<	One level back.

Selecting a parameter

⇒ The name of the parameter and the currently valid parameter value are displayed.
e.g.: **DEGAS OFF**

⇒ Select parameter. The value flashes and can now be edited.

Some parameters are not available for all gauges and thus not always displayed.

→ 28 29 30 31 32 32 33

	DEGAS	FSR	FILTER	OFFSET	GAS	COR	DIGITS
Sx TPR/PCR	-	-	✓	-	✓	✓	✓
Sx IKR	-	-	✓	-	✓	✓	✓
Sx PKR	-	-	✓	-	✓	✓	✓
Sx IMR	-	-	✓	-	✓ ^{*)}	✓	✓
Sx PBR	✓	-	✓	-	✓ ^{*)}	✓	✓
Sx CMR/APR	-	✓	✓	✓	-	✓	✓



^{*)} with restrictions.

Degas

Contamination deposits on the electrode system of hot cathode gauges may cause instabilities of the measurement values. The degas function facilitates cleaning of the electrode system.

Available for the following gauges:

- Pirani & Pirani Capacitance Gauge (TPR/PCR)
- Cold Cathode Gauge (IKR)
- FullRange[®] CC Gauge (PKR)
- Process Ion Gauge (IMR)
- FullRange[®] BA Gauge (PBR)
- Capacitance & Piezo Gauge (CMR/APR)

	Value	
DEGAS		
DEGAS OFF	⇒ Normal operation (Degas blocked)	
DEGAS ON	⇒ Degas: The electron collection grid is heated to ≈700 °C by electron bombardment and the electrode system is thus cleaned. Duration = 180 s.	

Editing and saving a parameter

 ⇒ Start Degas. Duration of the Degas function 180 seconds (may also be aborted).

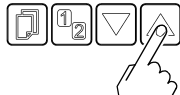
 Abort Degas.

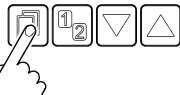
 ⇒ Save change and return to read mode.

Measuring range (F.S.) of linear gauges

For linear gauges, the full scale (F.S.) value has to be defined on the basis of the connected gauge type. For logarithmic gauges it is automatically recognized.

Available for the following gauges:

- Pirani & Pirani Capacitance Gauge (TPR/PCR)
- Cold Cathode Gauge (IKR)
- FullRange® CC Gauge (PKR)
- Process Ion Gauge (IMR)
- FullRange® BA Gauge (PBR)
- Capacitance & Piezo Gauge (CMR/APR)

	Value
FSR	
e.g. FSR 1000 MBAR	⇒ 0.01 hPa 0.1 hPa 1 hPa 10 hPa 100 hPa 1000 hPa 200 kPa 500 kPa 1000 kPa 5000 kPa
	A conversion table can be found in the Appendix (→ 56).

 ⇒ The value is increased/decreased by the defined increments.

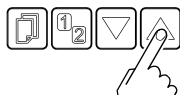
 ⇒ Save change and return to read mode.

Measurement value filter

The measurement value filter permits a better evaluation of unstable or disturbed measuring signals.

 The measurement value filter does not affect the analog output (→ 15).

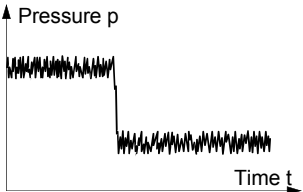
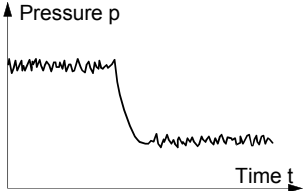
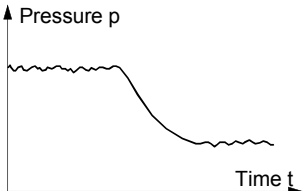
	Value
FILTER	
FILTER OFF	⇒ No measurement value filter
FILTER FAST	⇒ Fast: The TPG 36x responds quickly to fluctuations in the measurement value. As a result, it will respond faster to interference in the measured values.
	
FILTER NORMAL	⇒ Normal (factory setting): Good relationship between response and sensitivity of the display and the switching function to changes in the measured values.
	
FILTER SLOW	⇒ Slow: The TPG 36x does not respond to small changes in measured values. As a result, it will respond more slowly to changes in the measured values.
	

Editing and saving a parameter



⇒ The value is increased/decreased by the defined increments.

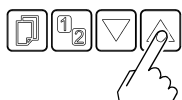

⇒ Save change and return to read mode.

Offset correction

The offset value is displayed and readjusted according to the actual measurement value.

Available for the following gauges:

- Pirani & Pirani Capacitance Gauge (TPR/PCR)
- Cold Cathode Gauge (IKR)
- FullRange® CC Gauge (PKR)
- Process Ion Gauge (IMR)
- FullRange® BA Gauge (PBR)
- Capacitance & Piezo Gauge (CMR/APR)

The offset correction affects:

- the displayed measurement value
- the displayed threshold value of the switching functions
- the analog outputs at the *control* connector (→ 15)

	Value	
OFFSET		
OFFSET OFF	⇒ Offset correction factory-deactivated	
e.g.: OFFSET 9.53	⇒ Offset correction activated (display in the relevant units of measurement)	

Editing and saving a parameter

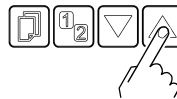

⇒ Press key for >1.5 s:
The offset value is readjusted (the actual measurement value is accepted as new offset value).



Reset the offset value.

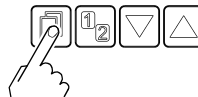

⇒ Save change and return to read mode.

When offset correction is activated, the saved offset value is subtracted from the actual measurement value. This allows measuring relative to a reference pressure.



When the zero of the gauge is readjusted, the offset correction must be deactivated.

Calibration factor GAS

The calibration factor GAS allows

- the measured value to be calibrated for the preset gases N₂, Ar, H₂, He, Ne, Kr and Xe, or
- manual input of the correction factor for other gases (COR).

→ Characteristic curves in [1] ... [14].



This parameter is not available for the unit of measurement: Volt.

Available for the following gauges:

- Pirani & Pirani Capacitance Gauge ¹⁾ (TPR/PCR))
- Cold Cathode Gauge (IKR)
- FullRange[®] CC Gauge ²⁾ (PKR)
- Process Ion Gauge (IMR)
- FullRange[®] BA Gauge ³⁾ (PBR)
- Capacitance & Piezo Gauge (CMR/APR)

¹⁾ Effective from pressure <1 hPa.

²⁾ Effective from pressure <1×10⁻⁵ hPa.

³⁾ Effective from pressure <1×10⁻² hPa.

	Value
GAS	
GAS N2	⇒ Gas: nitrogen / air (factory setting)
GAS AR	⇒ Gas: argon
GAS H2	⇒ Gas: hydrogen
GAS HE	⇒ Gas: helium
GAS NE	⇒ Gas: neon
GAS KR	⇒ Gas: krypton
GAS XE	⇒ Gas: xenon
GAS COR	⇒ Calibration factor for other gases by manually entering parameter COR

Editing and saving a parameter



⇒ The value is increased/decreased by the defined increments.

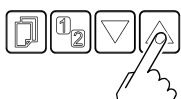

⇒ Save change and return to read mode.

Calibration factor COR

The calibration factor COR allows the measured value to be calibrated for other gases (→ characteristic curve in [1] ... [14]).

Precondition: Parameter "GAS COR" set.



This parameter is not available with the measurement unit: Volt.

Available for the following gauges:

- Pirani & Pirani Capacitance Gauge (TPR/PCR)
- Cold Cathode Gauge (IKR)
- FullRange® CC Gauge (PKR)
- Process Ion Gauge (IMR)
- FullRange® BA Gauge (PBR)
- Capacitance & Piezo Gauge (CMR/APR)

	Value	
COR		
e.g. COR 1.00	⇒ No correction	
e.g. COR 1.53	⇒ Measurement value corrected by a factor of 0.10 ... 10.00	

Editing and saving a parameter



⇒ The value is increased/decreased by the defined increments.

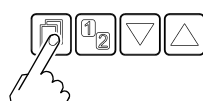
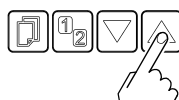

⇒ Save change and return to read mode.

Display resolution

Display resolution of measured values.

Available for the following gauges:

- Pirani & Pirani Capacitance Gauge (TPR/PCR)
- Cold Cathode Gauge (IKR)
- FullRange® CC Gauge (PKR)
- Process Ion Gauge (IMR)
- FullRange® BA Gauge (PBR)
- Capacitance & Piezo Gauge (CMR/APR)

	Value
DIGITS	
DIGITS AUTO	⇒ automatic ^{*)} (factory setting)
DIGITS 1	⇒ e.g. 2E-1 or 500
DIGITS 2	⇒ e.g. 2.5E-1 or 520
DIGITS 3	⇒ e.g. 2.47E-1 or 523
DIGITS 4	⇒ e.g. 2.473E-1 or 523.7

^{*)} The mantissa is dependent on the connected gauge and the currently valid pressure value.

With PCR gauges in the pressure range $p < 1.0E-4$ hPa and activated RNG-EXT (→ 40) the display is reduced by one decimal digit.

4.5.3 Gauge Control

SENSOR-CONTROL

The sensor control group is used for displaying, entering and editing parameters which define how the connected gauges are activated/deactivated.



If the connected gauges cannot be controlled (→ 35), this group is not available.

Parameters in this group

- S-ON** Gauge activation
- S-OFF** Gauge deactivation
- T-ON** ON threshold
- T-OFF** OFF threshold
- <** One level back

Selection of parameter

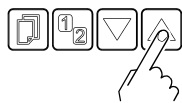

⇒ The name of the parameter and the currently valid parameter value are displayed.

e.g.: **S-ON HAND**
Manual activation



⇒ Select parameter. The value flashes and can now be edited.

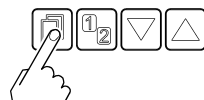

Some parameters are not available for all gauges and thus not always displayed.

→ 35 36 36 38

	S-ON	T-ON	S-OFF	T-OFF
Sx TPR/PCR	-	-	-	-
Sx IKR	✓	✓	✓	✓
Sx PKR	✓	-	✓	-
Sx IMR	✓	✓	✓	✓
Sx PBR	✓	✓	✓	✓
Sx CMR/APR	-	-	-	-



Gauge activation

Certain gauges can be activated by different means.

The following gauges can be controlled:

- Pirani & Pirani Capacitance Gauge (TPR/PCR)
- Cold Cathode Gauge (IKR)
- FullRange® CC Gauge *) (PKR)
- Process Ion Gauge (IMR)
- FullRange® BA Gauge (PBR)
- Capacitance & Piezo Gauge (CMR/APR)

*) except by a gauge connected to the other measurement channel.

	Value
S-ON	
S-ON HAND	⇒ Manual activation: The gauge is activated by pressing the  key.
S-ON EXTERNAL	⇒ External activation: The gauge is activated by an input signal fed via the <control> connector →  15).
S-ON HOTSTART	⇒ Hot start: The gauge is automatically activated when the TPG 36x is turned on. Measurement is thus automatically resumed after a power failure. Gauge deactivation →  36.
S-ON CH 1 (TPG 362 only)	⇒ Automatic activation: The gauge is activated by one of the following gauges connected to measurement channel 1: <ul style="list-style-type: none"> <input checked="" type="checkbox"/> Pirani & Pirani Capacitance Gauge (TPR/PCR) <input type="checkbox"/> Cold Cathode Gauge (IKR) <input checked="" type="checkbox"/> FullRange® CC Gauge (PKR) <input checked="" type="checkbox"/> Process Ion Gauge (IMR) <input checked="" type="checkbox"/> FullRange® BA Gauge (PBR) <input checked="" type="checkbox"/> Capacitance Gauge *) (CMR/APR)
S-ON CH 2 (TPG 362 only)	⇒ Automatic activation: The gauge is activated by one of the following gauges connected to measurement channel 2: <ul style="list-style-type: none"> <input checked="" type="checkbox"/> Pirani & Pirani Capacitance Gauge (TPR/PCR) <input checked="" type="checkbox"/> Pirani Capacitance Gauge (PCR) <input type="checkbox"/> Cold Cathode Gauge (IKR) <input checked="" type="checkbox"/> FullRange® CC Gauge (PKR) <input checked="" type="checkbox"/> Process Ion Gauge (IMR) <input checked="" type="checkbox"/> FullRange® BA Gauge (PBR) <input checked="" type="checkbox"/> Capacitance & Piezo Gauge *) (CMR/APR)

*) only gauges with 1, 10 or 100 hPa F.S.

*) only gauges with 1, 10 or 100 hPa F.S.

Editing and saving a parameter



⇒ The value is increased/decreased by the defined increments.

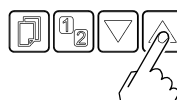

⇒ Save change and return to read mode.

ON threshold (TPG 362 only)

Definition of the ON threshold for the gauge to be activated by a gauge connected to the other measurement channel.

Available for the following following gauges:

- Pirani & Pirani Capacitance Gauge (TPR/PCR)
- Cold Cathode Gauge (IKR)
- FullRange® CC Gauge (PKR)
- Process Ion Gauge (IMR)
- FullRange® BA Gauge (PBR)
- Capacitance & Piezo Gauge (CMR/APR)

	Value
T-ON	
e.g.: T-ON 1.00	→ table below.

	TPR PCR	PKR IMR PBR	CMR, APR		
			F.S.=1	F.S.=10	F.S.=100
IKR	10 ⁻³ ...10 ⁻²	10 ⁻⁵ ...10 ⁻²	10 ⁻³ ...10 ⁻²	—	—
IMR	10 ⁻³ ...1	10 ⁻⁵ ...1	10 ⁻³ ...1	10 ⁻² ...1	10 ⁻¹ ...1
PBR	10 ⁻³ ...1	10 ⁻⁵ ...1	10 ⁻³ ...1	10 ⁻² ...1	10 ⁻¹ ...1

all values in hPa, CAL=1

*) 10⁻⁴ hPa, if PrE is activated (→ 40)



Value **T-OFF** must be ≥ **T-ON**.

Editing and saving a parameter

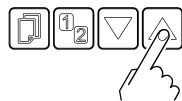

⇒ Press key for <1 s:
The value is increased/decreased by 1 increment.



Press key for >1 s:
The value is increased/decreased continuously.

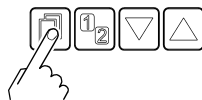

⇒ Save change and return to read mode.

Gauge deactivation

Certain gauges can be deactivated by different means.

The following gauges can be controlled:

- Pirani & Pirani Capacitance Gauge (TPR/PCR)
- Cold Cathode Gauge (IKR)
- FullRange® CC Gauge *, **) (PKR)
- Process Ion Gauge *) (IMR)
- FullRange® BA Gauge *) (PBR)
- Capacitance & Piezo Gauge (CMR/APR)

*) except for self control

**) except by a gauge connected to the other measurement channel.

	Value
S-OFF	
S-OFF HAND	⇒ Manual deactivation: The gauge is deactivated by pressing the <input type="checkbox"/> key
S-OFF EXTERN	⇒ External deactivation: The gauge is deactivated by an input signal via the <control> connector → 15).
S-OFF SELF (also with Cold Cathode Gauge)	⇒ Self control: The gauge deactivates itself when the pressure rises (→ 38).
S-OFF CH 1 (only TPG 362)	⇒ Automatic deactivation: The gauge is deactivated by one of the following gauges connected to measurement channel 1: <input checked="" type="checkbox"/> Pirani & Pirani Capacitance Gauge (TPR/PCR) <input type="checkbox"/> Cold Cathode Gauge (IKR) <input checked="" type="checkbox"/> FullRange® CC Gauge (PKR) <input checked="" type="checkbox"/> Process Ion Gauge (IMR) <input checked="" type="checkbox"/> FullRange® BA Gauge (PBR) <input checked="" type="checkbox"/> Capacitance & Piezo Gauge *) (CMR/APR) *) only for gauges with 1, 10 or 100 hPa F.S.
S-OFF CH 2 (only TPG 362)	⇒ Automatic deactivation: The gauge is deactivated by one of the following gauges connected to measurement channel 2: <input checked="" type="checkbox"/> Pirani & Pirani Capacitance Gauge (TPR/PCR) <input type="checkbox"/> Cold Cathode Gauge (IKR) <input checked="" type="checkbox"/> FullRange® CC Gauge (PKR) <input checked="" type="checkbox"/> Process Ion Gauge (IMR) <input checked="" type="checkbox"/> FullRange® BA Gauge (PBR) <input checked="" type="checkbox"/> Capacitance & Piezo Gauge *) (CMR/APR) *) only gauges with 1, 10 or 100 hPa F.S.

Editing and saving a parameter

⇒ The value is increased/decreased by the defined increments.

⇒ Save change and return to read mode.

OFF threshold (TPG 361 only)

Definition of the OFF threshold for the gauge to be deactivated by itself.

- Available for othe following gauges:
- Pirani & Pirani Capacitance Gauge (TPR/PCR)
 - Cold Cathode Gauge (IKRx)
 - FullRange® CC Gauge (PKR)
 - Process Ion Gauge (IMR)
 - FullRange® BA Gauge (PBR)
 - Capacitance & Piezo Gauge (CMR/APR)

	Value
T-OFF	
e.g.: T-OFF 0.001	10 ⁻⁵ ... 10 ⁻² hPa, GAS = N ₂

Editing and saving a parameter

⇒ Press key for <1 s:
The value is increased/decreased by 1 increment.

Press key for >1 s:
The value is increased/decreased continuously.

⇒ Save change and return to read mode.

OFF threshold
(TPG 362 only)

Definition of the OFF threshold for the gauge to be deactivated by a gauge connected to the other measurement channel or by itself.

Available for the following gauges:

- Pirani & Pirani Capacitance Gauge (TPR/PCR)
- Cold Cathode Gauge (IKRx)
- FullRange® CC Gauge (PKR)
- Process Ion Gauge (IMR)
- FullRange® BA Gauge (PBR)
- Capacitance & Piezo Gauge (CMR/APR)

	Value
T-OFF	
e.g.: T-OFF 0.001	→ table below.

	TPR PCR	PKR IMR PBR	CMR, APR		
			F.S.=1	F.S.=10	F.S.=100
IKR	10 ⁻³ ...10 ⁻²	10 ⁻⁵ ...10 ⁻²	10 ⁻³ ...10 ⁻²	—	—
IMR	10 ⁻³ ...1	10 ⁻⁵ ...1	10 ⁻³ ...1	10 ⁻² ...1	10 ⁻¹ ...1
PBR	10 ⁻³ ...1	10 ⁻⁵ ...1	10 ⁻³ ...1	10 ⁻² ...1	10 ⁻¹ ...1

all values in hPa, CAL=1

*) 10⁻⁴ hPa, if RNG-EXT is activated (→ 40)

Value **T-OFF** must be ≥ **T-ON**.

Editing and saving a parameter

⇒ Press key for <1 s:
The value is increased/decreased by 1 increment.

Press key for >1 s:
The value is increased/decreased continuously.

⇒ Save change and return to read mode.

4.5.4 General Parameters

Parameters in this group

GENERAL	>	The General parameters group is used for displaying, entering and editing generally applicable system parameters.
UNIT		Measurement unit
BAUD USB		Transmission rate USB interface
RNG-EXT		Pirani range extension
ERR-RELAY		Error relay
PE-UR		Penning underrange
BARGRAPH		Bar graph display
ADDRESS		RS485 node address
PROTOCOL		Protocol serial interface
BACKLIGHT		Backlight
SCREENSAVE		Screensave
CONTRAST		Contrast adjustment
DEFAULT		Factory settings
LANGUAGE		Language
FORMAT		Number format, measurement value
END VAL		Display of measurement range end value
<		One level back

Selecting a parameter

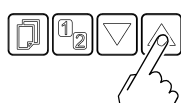

⇒ The name of the parameter and the currently valid parameter value are displayed.

e.g.: **UNIT PASCAL**
Measurement unit



⇒ Select parameter. The value flashes and can now be edited.

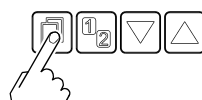

Editing and saving a parameter



⇒ The value is increased/decreased by the defined increments.

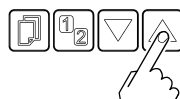

⇒ Save change and return to read mode.

Measurement unit

Unit of measured values, thresholds etc. See Appendix for conversion table (→ 56).

	Value
UNIT	
UNIT MBAR	⇒ mBar
UNIT HPASCAL	⇒ hPa (factory setting)
UNIT TORR	⇒ Torr (only available if Torr lock is not activated → 46)
UNIT PASCAL	⇒ Pa
UNIT MICRON	⇒ Micron (= 0.001 Torr) (only available if Torr lock is not activated → 46)
UNIT VOLT	⇒ V

TPG 361 only: If the measurement unit micron is selected, automatic changeover to Torr occurs above 99000 micron. Below 90 Torr automatic changeover back to the measurement unit micron occurs.

Transmission rate

Transmission rate of the USB interface.

The transmission rate of the RS485 interface is 9600 baud and cannot be changed.

	Value
BAUD USB	
BAUD USB 9600	⇒ 9600 baud (factory setting)
BAUD USB 19200	⇒ 19200 baud
BAUD USB 38400	⇒ 38400 baud
BAUD USB 57600	⇒ 57600 baud
BAUD USB 115200	⇒ 115200 baud

Pirani range extension

The display and setpoint adjustment range of the Pirani Capacitance Gauge can be extended.

Available for the following gauge(s):

		Measurement range
<input type="checkbox"/>	Pirani Gauge	(TPR)
<input checked="" type="checkbox"/>	Pirani Capacitance Gauge	(PCR) 5×10 ⁻⁵ ...1500 hPa
<input type="checkbox"/>	Cold Cathode Gauge	(IKR)
<input type="checkbox"/>	FullRange [®] CC Gauge	(PKR)
<input type="checkbox"/>	Process Ion Gauge	(IMR)
<input type="checkbox"/>	FullRange [®] BA Gauge	(PBR)
<input type="checkbox"/>	Capacitance & Piezo Gauge	(CMR/APR)

	Value
RNG-EXT	
RNG-EXT DISABLED	⇒ Deactivated (factory setting)
RNG-EXT ENABLED	⇒ Display and setpoint adjustment range extended to 5×10 ⁻⁵ hPa

Error relay

Switching behaviour of the error relay.

	Value
ERR-RELAY	
ERR-RELAY ALL	⇒ Switches for all errors (factory setting)
ERR-RELAY no SE	⇒ Only unit errors
ERR-RELAY CH 1	⇒ Error sensor 1 and unit error
ERR-RELAY CH 2	⇒ Error sensor 2 and unit error (only TPG 362)

Underrange control

Definition of behaviour in the event of an underrange with Cold Cathode Gauges (Penning underrange control).

Available for the following gauges:

- Pirani & Pirani Capacitance Gauge (TPR/PCR)
- Cold Cathode Gauge (IKR)
- FullRange® CC Gauge (PKR)
- Process Ion Gauge (IMR)
- FullRange® BA Gauge (PBR)
- Capacitance & Piezo Gauge (CMR/APR)

There are a number of possible causes of an underrange:

- the pressure in the vacuum system is lower than the measurement range
- the measurement element has not (yet) ignited.
- discharge has failed
- a fault has occurred

Caution

Caution: relay is switching

An underrange can lead to unintended reactions of the connected control system.

Prevent false control signals and messages by disconnecting the sensor and control cables.

	Value
PE-UR	
PE-UR DISABLED	⇒ Factory setting. Underrange state is interpreted as an admissible measurement value. UR is displayed. The switching function remains ON.
PE-UR ENABLED	⇒ Underrange state is interpreted as an admissible measurement value. UR is displayed. The switching function remains OFF.



If there is a possibility of the pressure in the vacuum system dropping below the measurement range of the gauge, it is advisable to select **PE-UR DISABLED**.

If **PE-UR ENABLED** is selected, evaluation of the switching function is suppressed for 10 seconds when the gauge is turned on and each time after an underrange has recurred. During this time, the switching function remains OFF.

Bar graph

In the dot matrix a bar graph or the measured pressure as a function of time ($p = f(t)$) may be shown.

During parameter setting the parameter and the parameter value may be displayed in place of this.

	Value
BARGRAPH	
BARGRAPH OFF	⇒ Factory setting.
BARGRAPH FSR	⇒ Bar graph covering full scale range.
BARGRAPH FSR h	⇒ Bar graph covering full scale range, high-level presentation.
BARGRAPH FSR+SP	⇒ Bar graph covering full scale range and setpoint threshold.
BARGRAPH DEC	⇒ Bar graph covering a decade according to current measurement value.
BARGRAPH DEC h	⇒ Bar graph covering a decade according to current measurement value, high-level presentation.
BARGRAPH DEC+SP	⇒ Bar graph covering a decade according to current measurement value and setpoint threshold.
BARGRAPH f(0.2s)	⇒ $p = f(t)$, autoscaled, 0.2 seconds / pixel For each measurement every 200 ms a measurement value is saved in tabular form and the last 100 measurement values (=100 pixel) are shown autoscaled. The represented data string corresponds to a logging duration of 20 seconds.
BARGRAPH f(1s)	⇒ $p = f(t)$, autoscaled, 1 second / pixel For each measurement every second a measurement value is saved in tabular form and the last 100 measurement values (=100 pixel) are shown autoscaled. The represented data string corresponds to a logging duration of 100 seconds.
BARGRAPH f(6s)	⇒ $p = f(t)$, autoscaled, 6 seconds / pixel For each measurement every 6 seconds a measurement value is saved in tabular form and the last 100 measurement values (=100 pixel) are shown autoscaled. The represented data string corresponds to a logging duration of 10 minutes.
BARGRAPH f(1min)	⇒ $p = f(t)$, autoscaled, 1 minute / pixel For each measurement every minute a measurement value is saved in tabular form and the last 100 measurement values (=100 pixel) are shown autoscaled. The represented data string corresponds to a logging duration of 100 minutes.

Address

RS485 node address.

	Value
ADDRESS	
ADDRESS 01	⇒ factory setting
:	
ADDRESS 24	adjustable from 1 ... 24

Protocol

Protocol serial interface (RS485, USB B, ethernet).

	Value
PROTOCOL	
PROTOCOL AUTO	⇒ automatic recognition (factory setting)
PROTOCOL PV	⇒ Pfeiffer Vacuum protocol
PROTOCOL MNE	⇒ mnemonics protocol

Backlight

	Value
BACKLIGHT	
e.g. BACKLIGHT 60%	⇒ Factory setting Adjustable from 0 ... 100% 100% = full brightness

Screensave

	Value
SCREENSAVE	
SCREENSAVE OFF	⇒ factory setting
SCREENSAVE 10min	⇒ after 10 minutes
SCREENSAVE 30min	⇒ after 30 minutes
SCREENSAVE 1h	⇒ after 1 hour
SCREENSAVE 2h	⇒ after 2 hours
SCREENSAVE 8h	⇒ after 8 hours

Contrast

	Value
CONTRAST	
e.g. CONTRAST 40%	⇒ factory setting adjustable from 0 ... 100 % 100% = full contrast

Default parameter settings

All user parameter settings are replaced by the default values (factory settings).



Loading of the default parameter settings is irreversible.

	Value
DEFAULT	
DEFAULT ▼+▲ 2s	Press keys at the same time for >2 s to start loading default values
DEFAULT SET	⇒ The default values are loaded

Language

Display language.

	Value
LANGUAGE	
LANGUAGE ENGLISH	⇒ English (factory setting)
LANGUAGE GERMAN	⇒ German
LANGUAGE FRENCH	⇒ French

Measurement value format

Measurement values in floating point or exponential format. If a measurement value cannot reasonably be expressed in the floating point format, it is automatically displayed in the exponential format.

	Value
FORMAT	
FORMAT X.X	⇒ Floating point format, if possible (factory setting)
FORMAT X.XESY	⇒ Exponential format

Display of measurement range end value

Display of underrange or overrange.

	Value
END VAL	
END VAL UR/OR	⇒ When an underrange or overrange occurs UR or OR is displayed (factory setting)
END VAL VALUE	⇒ When an underrange or overrange occurs the respective full scale value is displayed

4.5.5 Test Parameters

TEST >

The Test parameter group is used for displaying the firmware version, entering and editing special parameter values, and for running test programs.



The group is only available if the  key was pressed while the TPG 36x was turned on.

Parameters in this group

SOFTWARE	Firmware version
HARDWARE	Hardware version
MAC	MAC address
RUNHOURS	Operating hours
WATCHDOG	Watchdog control
TORR-LOCK	Torr lock
KEY-LOCK	Keylock
FLASH	FLASH test (program memory)
EEPROM	EEPROM test (parameter memory)
DISPLAY	Display test
I/O	I/O test
<	One level back

The parameters in this group are available for all gauges.

Selecting a parameter

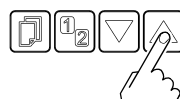

⇒ The name of the parameter and the currently valid parameter value are displayed.

e.g.: **SOFTWARE 010100**
Firmware version

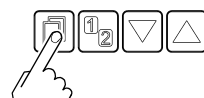

⇒ Select parameter. The value flashes and can now be edited.

Editing and saving a parameter



⇒ The value is increased/decreased by the defined increments.

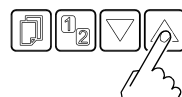

⇒ Save change and return to read mode.

Firmware version

The firmware version (program version) is displayed.

	Version
e.g. SOFTWARE 010100	This information is helpful when contacting Pfeiffer Vacuum

Hardware version

The hardware version is displayed.

	Hardware
e.g. <code>HARDWARE 010100</code>	This information is helpful when contacting Pfeiffer Vacuum

Operating hours

The operating hours are displayed.

	Hours
e.g. <code>RUNHOURS 24 h</code>	⇒ Operating hours

Watchdog control

Behaviour of the system control (watchdog control) in the event of an error.

	Setting
<code>WATCHDOG</code>	
<code>WATCHDOG AUTO</code>	⇒ The system automatically acknowledges error messages of the watchdog after 2 s (factory setting)
<code>WATCHDOG OFF</code>	⇒ Error messages of the watchdog have to be acknowledged by the operator

Torr lock

The measurement unit Torr can be suppressed in the corresponding parameter setting `UNIT TORR` (→ 40).

	Setting
<code>TORR-LOCK</code>	
<code>TORR-LOCK OFF</code>	⇒ Measurement unit Torr available (factory setting)
<code>TORR-LOCK ON</code>	⇒ Measurement unit Torr not available



Keylock

The keylock function prevents inadvertent entries in the parameter mode and thus malfunctions.

	Setting
<code>KEY-LOCK</code>	
<code>KEY-LOCK OFF</code>	⇒ Keylock function disabled (factory setting)
<code>KEY-LOCK ON</code>	⇒ Keylock function enabled



FLASH test

Test of the program memory.

	Test sequence
<pre>FLASH ▼+▲ FLASH RUN FLASH PASS FLASH ERROR</pre>	<p>Press   keys at the same time to start test</p> <ul style="list-style-type: none"> ⇒ Test in progress (very briefly) ⇒ Test completed, no error found. After the test, an 8-digit checksum (e.g. FLASH 0x12345678) is displayed. ⇒ Test completed, error found. After the test, an 8-digit checksum (e.g. FLASH 0x12345678) is displayed. If the error persists after repeating the test, please contact your nearest Pfeiffer Vacuum service center.



EEPROM test

Test of the parameter memory.

	Test sequence
<pre>EEPROM ▼+▲ EEPROM RUN EEPROM PASS EEPROM ERROR</pre>	<p>Press   keys at the same time to start test</p> <ul style="list-style-type: none"> ⇒ Test in progress. ⇒ Test completed, no error found. ⇒ Test completed, error found. If the error persists after repeating the test, please contact your nearest Pfeiffer Vacuum service center.

Display test

Test of the display.

	Test sequence
<pre>DISPLAY ▼+▲</pre>	<p>Press   keys at the same time to start test</p> <ul style="list-style-type: none"> ⇒ After starting the test, all display elements are lit at the same time for 10 s.

I/O test

Test of the unit relays. The test program tests their switching function.

 **Caution**



Caution: The relays switch irrespective of the pressure. Starting a test program may cause unwanted effects in connected control systems.

Disconnect all sensor and control system lines to ensure that no control commands or messages are triggered by mistake.

The relays switch on and off cyclically. The switching operations are indicated optically and are also clearly audible.

The switching function contacts are connected to the *control* connector on the rear of the unit (→  15). Check their function with an ohmmeter.

	Test sequence
I/O ▼+▲	Press keys at the same time to start test
I/O OFF	⇒ All relays deactivated
I/O REL1 ON	⇒ Switching function relay 1
I/O REL1 OFF	⇒ Switching function relay 1
I/O REL2 ON	⇒ Switching function relay 2
I/O REL2 OFF	⇒ Switching function relay 2
I/O REL3 ON	⇒ Switching function relay 3
I/O REL3 OFF	⇒ Switching function relay 3
I/O REL4 ON	⇒ Switching function relay 4
I/O REL4 OFF	⇒ Switching function relay 4
I/O REL5 ON	⇒ Gauge relay CH1
I/O REL5 OFF	⇒ Gauge relay CH1
I/O REL6 ON	⇒ Gauge relay CH2
I/O REL6 OFF	⇒ Gauge relay CH2
I/O REL7 ON	⇒ Error relay
I/O REL7 OFF	⇒ Error relay

4.6 Data Logger Mode

DATA LOGGER

The data logger group is used for

- displaying measurement data on a USB memory stick (interface type A on the front of the TPG 36x)
- deleting displayed measurement data from the USB memory stick



This group is only available when a USB memory stick formatted for the FAT file system (FAT32) is plugged in. Use a max. 32 GB memory stick.



Not all USB memory sticks are automatically recognized by the TPG 36x, as they (in particular cheaper brands) do not always conform to USB standard requirements. Try a different memory stick before contacting your nearest Pfeiffer Vacuum service center.

Parameters in this group

DATE	Current date
TIME	Current time
INTERVAL	Display interval
DEC-SEPARATOR	Decimal separator
FILENAME	File name
START / STOP	Start / stop display
CLEAR	Deletion of files with displayed measurement data

Selecting a parameter

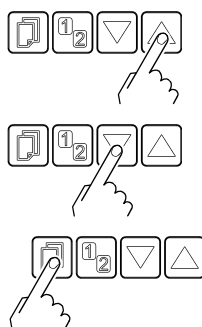

⇒ The name of the parameter and the currently valid parameter value are displayed.

e.g.: **INTERVAL 1s**
Display interval

⇒ Select parameter. The value flashes and can now be edited.

Editing and saving a parameter

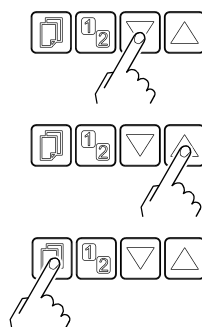

⇒ The value is increased/decreased by the defined increments.

⇒ Save change and return to read mode.

Date

	Value
DATE	Current date in the format YYYY-MM-DD
e.g. DATE 2014-03-26	⇒ e.g. 2014-03-26

Time

	Value
TIME	Current time in the format hh:mm [24 h]
e.g. TIME 15:45	⇒ e.g. 15:45

Interval

Data logging interval.

	Value
INTERVAL	
INTERVAL 1s	⇒ Display interval 1/s
INTERVAL 10s	⇒ Display interval 1/10 s
INTERVAL 30s	⇒ Display interval 1/30 s
INTERVAL 1min	⇒ Display interval 1/60 s
INTERVAL 1%	⇒ Display interval: in the event of measurement value changes ≥1%
INTERVAL 5%	⇒ Display interval: in the event of measurement value changes ≥5%

Decimal separator

Decimal separator for measurement values in the measurement data file.



	Wert
DEC-SEPARATOR	
DEC-SEPARATOR ,	⇒ Decimal comma
DEC-SEPARATOR .	⇒ Decimal point

File name	Value
FILENAME	Name of the measurement data file, max. 7 digits
e.g. FILENAME DATALOG	⇒ File ending: CSV

Start / Stop



Starting / stopping measurement value display.

 The number of the respective measurement channel (1, 2) flashes during measurement data display.

	Value
START	
START ▲	⇒ Press  key to start saving
STOP ▼	⇒ Press  key to stop saving

Deletion

Deletion of all measurement data files (ending CSV) from USB memory stick.

	Value
CLEAR ▼+▲	Press   keys at the same time to delete files
CLEAR RUNNING	⇒ CSV files are being deleted
CLEAR DONE	⇒ CSV files have been deleted

4.7 Setup Mode

SETUP 	This group is used for <ul style="list-style-type: none"> • saving all parameters on a USB memory stick (interface type A on the front of the TPG 36x) • loading all parameters from a USB memory stick onto the TPG 36x • formatting a USB memory stick • deleting files with saved parameters from the USB memory stick
--	---

 This group is only available when a USB memory stick formatted for the FAT file system (FAT32) is plugged in. Use a max. 32 GB memory stick.

Parameters in this group

SAVE	Saving all parameters
RESTORE	Loading all parameters onto the TPG 36x
FORMAT	Formatting USB memory stick (FAT32)
CLEAR	Deletion of files with saved parameters
<	One level back

Selecting a parameter



⇒ The name of the parameter and the currently valid parameter value are displayed.

e.g.: **SAVE SETUP**
Saving all parameters

⇒ Select parameter. The value flashes and can now be edited.

Editing and saving a parameter

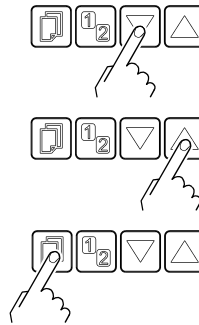

⇒ The value is increased/decreased by the defined increments.

⇒ Save change and return to read mode.

Saving a parameter

Saving all parameters of the TPG 36x to a USB memory stick (file ending: CSV).

	Value
SAVE	
SAVE SETUP	⇒ File name on the USB memory stick: SETUP01.CSV
:	
SAVE SETUP99	⇒ File name on the USB memory stick: SETUP99.CSV
SAVE RUNNING	⇒ CSV file is being saved
SAVE DONE	⇒ Saving completed



Loading a parameter

Loading all parameters from a USB memory stick onto the TPG 36x.

	Value
RESTORE	
RESTORE SETUP01	⇒ File name on the USB memory stick: SETUP.CSV
:	
RESTORE SETUP99	⇒ File name on the USB memory stick: SETUP99.CSV



Formatting

Formatting USB memory stick.

	Value
FORMAT ▼+▲	Press   keys at the same time to start formatting
FORMAT RUNNING	⇒ Formatting in progress
FORMAT DONE	⇒ Formatting completed

Deleting

Deleting all parameter files (ending CSV) from the USB memory stick.

	Value
CLEAR ▼+▲	Press   keys at the same time to delete files
CLEAR RUNNING	⇒ CSV files are being deleted
CLEAR DONE	⇒ CSV files have been deleted

5 Maintenance

Cleaning the TPG 36x

For cleaning the outside of the unit a slightly moist cloth will usually do. Do not use any aggressive or scouring cleaning agents.

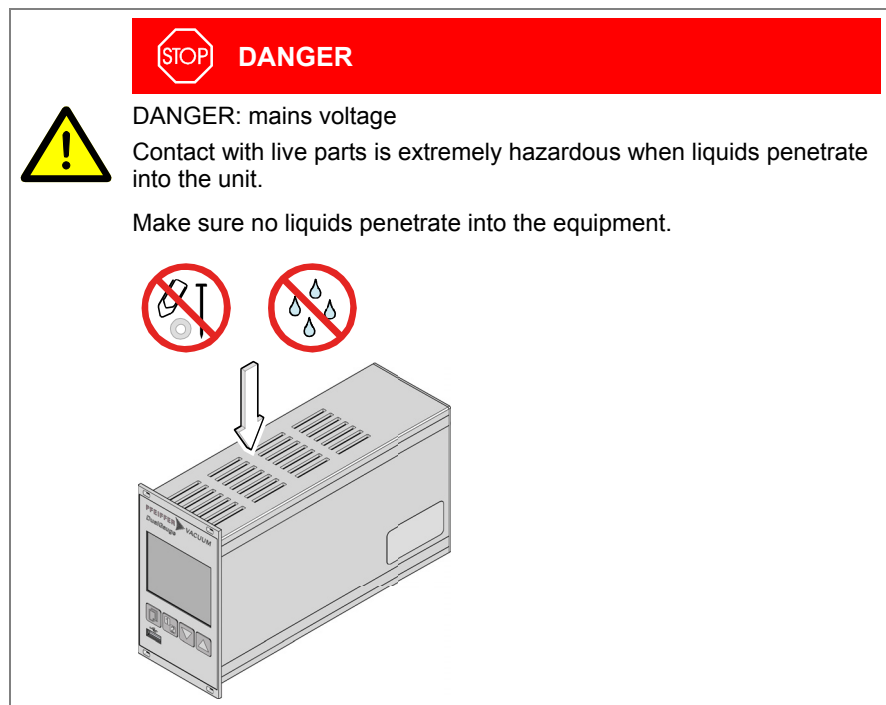

Battery replacement

The product contains a battery (type CR2032, service life >10 years) in order to maintain the data integrity of the real-time clock. Battery replacement is necessary if the real-time clock repeatedly shows an incorrect date. Please contact your local Pfeiffer Vacuum service center.

6 Troubleshooting

Signalization of errors



and the error relay opens (→ 15).

Error messages

	Possible cause and remedy/acknowledgement
SENSOR ERROR	<p>Interruption or instability in sensor line or connector (Sensor error).</p> <p>⇒ Acknowledge with the key. If the problem persists, Sx noSENSOR or Sx noIDENT is displayed.</p>
WATCHDOG ERROR	<p>Possible cause and remedy/acknowledgement</p> <p>The TPG 36x has been turned on too fast after power off.</p> <p>⇒ Acknowledge with the key. If the watchdog is set to Auto, the TPG 36x acknowledges the message automatically after 2 s (→ 46).</p> <p>The watchdog has tripped because of a severe electric disturbance or an operating system error.</p> <p>⇒ Acknowledge with the key. If the watchdog is set to WATCHDOG AUTO, the TPG 36x acknowledges the message automatically after 2 s (→ 46).</p>
UART ERROR	<p>Possible cause and remedy/acknowledgement</p> <p>Error in UART.</p> <p>⇒ Acknowledge with the key.</p>
PROGRAM CORRUPT	<p>Possible cause and remedy/acknowledgement</p> <p>Program memory error (FLASH).</p> <p>⇒ Acknowledge with the key.</p>
DATA CORRUPTED	<p>Possible cause and remedy/acknowledgement</p> <p>Parameter memory error (EEPROM).</p> <p>⇒ Acknowledge with the key.</p>
DISPLAY ERROR	<p>Possible cause and remedy/acknowledgement</p> <p>Display driver error.</p> <p>⇒ Acknowledge with the key.</p>
A/D ERROR	<p>Possible cause and remedy/acknowledgement</p> <p>A/D converter error.</p> <p>⇒ Acknowledge with the key.</p>

Technical support



If the problem persists after the message has been acknowledged several times and/or the gauge has been exchanged, please contact your nearest Pfeiffer Vacuum service center.

7 Repair

Return defective products to your nearest Pfeiffer Vacuum service center for repair. Pfeiffer Vacuum assumes no liability and the warranty is rendered null and void if repair work is carried out by the end-user or by third parties.

8 Storage

Caution



Caution: electronic components.
 Inappropriate storage (static electricity, humidity etc.) may damage electronic components.
 Store the product in an antistatic bag or container. Observe the relevant specifications under Technical Data (→ 7).

9 Disposal

WARNING



WARNING: substances detrimental to the environment.
 Products or parts thereof (mechanical and electric components, operating fluids etc.) may be detrimental to the environment.
 Please dispose of such materials in accordance with the relevant local regulations.

Separating the components

Non-electronic components

Electronic components

After disassembling the product, separate its components in accordance with the following criteria:

Such components must be separated according to their materials and recycled.

Such components must be separated according to their materials and recycled.

Appendix

A: Conversion Tables

Weights

	kg	lb	slug	oz
kg	1	2.205	68.522×10^{-3}	35.274
lb	0.454	1	31.081×10^{-3}	16
slug	14.594	32.174	1	514.785
oz	28.349×10^{-3}	62.5×10^{-3}	1.943×10^{-3}	1

Pressures

	N/m ² , Pa	Bar	mBar, hPa	Torr	at
N/m ² , Pa	1	10×10^{-6}	10×10^{-3}	7.5×10^{-3}	9.869×10^{-6}
Bar	100×10^3	1	10^3	750.062	0.987
mBar, hPa	100	10^{-3}	1	750.062×10^{-3}	0.987×10^{-3}
Torr	133.322	1.333×10^{-3}	1.333	1	1.316×10^{-3}
at	101.325×10^3	1.013	1.013×10^3	760	1

Pressure units used in the vacuum technology

	mBar	Bar	Pa	hPa	kPa	Torr mm HG
mBar	1	1×10^{-3}	100	1	0.1	0.75
Bar	1×10^3	1	1×10^5	1×10^3	100	750
Pa	0.01	1×10^{-8}	1	0.01	1×10^{-3}	7.5×10^{-3}
hPa	1	1×10^{-3}	100	1	0.1	0.75
kPa	10	0.01	1×10^3	10	1	7.5
Torr mm HG	1.332	1.332×10^{-3}	133.32	1.3332	0.1332	1

$$1 \text{ Pa} = 1 \text{ N/m}^2$$

Linear measurements

	mm	m	inch	ft
mm	1	10^{-3}	39.37×10^{-3}	3.281×10^{-3}
m	10^3	1	39.37	3.281
inch	25.4	25.4×10^{-3}	1	8.333×10^{-2}
ft	304.8	0.305	12	1

Temperature

	Kelvin	Celsius	Fahrenheit
Kelvin	1	$^{\circ}\text{C} + 273.15$	$(^{\circ}\text{F} + 459.67) \times 5/9$
Celsius	$\text{K} - 273.15$	1	$5/9 \times ^{\circ}\text{F} - 17.778$
Fahrenheit	$9/5 \times \text{K} - 459.67$	$9/5 \times (^{\circ}\text{C} + 17.778)$	1

B: Firmware Update



If your TPG 36x firmware needs updating, e.g. for implementing a new gauge type, please contact your nearest Pfeiffer Vacuum service center.

A firmware update is possible

- via a USB memory stick (type A connector on the front of the unit), or
- with the USB Update Tool via the USB type B connector on the rear of the unit.

User Parameters

Most of the settings you may have made in the Parameter mode will not be affected by a firmware update. However, we recommend that you save the parameters before an update (→ 50).

Firmware update with a USB memory stick (type A)



Not all USB memory sticks are automatically recognized by the TPG 36x, as they (particularly cheaper brands) do not always conform to USB standard specifications. Try a different memory stick before contacting your nearest Pfeiffer Vacuum service center.

- 1 Download two files with the ending ".S19" and ".CNF" from our website "www.pfeiffer-vacuum.com" to a USB memory stick.
- 2 Switch off the unit.
- 3 Plug in the memory stick and then turn on the unit.
- 4 The update occurs automatically in the following steps:

BOOTING	Very brief.
BOOTLOADER V1.x	Very brief.
ERASING FW...	Old firmware is being deleted from the unit.
UPDATING FW...	New firmware is being loaded onto the unit.
UPDATE COMPLETE	Update completed.

- 5 Remove the memory stick and the unit will restart automatically.
- 6 If necessary, customer-specific settings saved before the update may now be resaved to the unit (→ 50).

Firmware update with USB Update Tool (USB type B)

Precondition: Windows XP, 7 or 8 operating system



During firmware update, no USB memory stick should be connected on the front of the unit.



If a virtual serial interface (COM) is not automatically established, you may download and then install the driver from the website "www.ftdichip.com/drivers/vcp.htm".

- 1 Download the USB UpdateTool from our website "www.pfeiffer-vacuum.com".
- 2 Using a USB cable type A/B connect the unit to the PC.

- Start USB UpdateTool, select the COM interface from the menu and click on <Connect>.

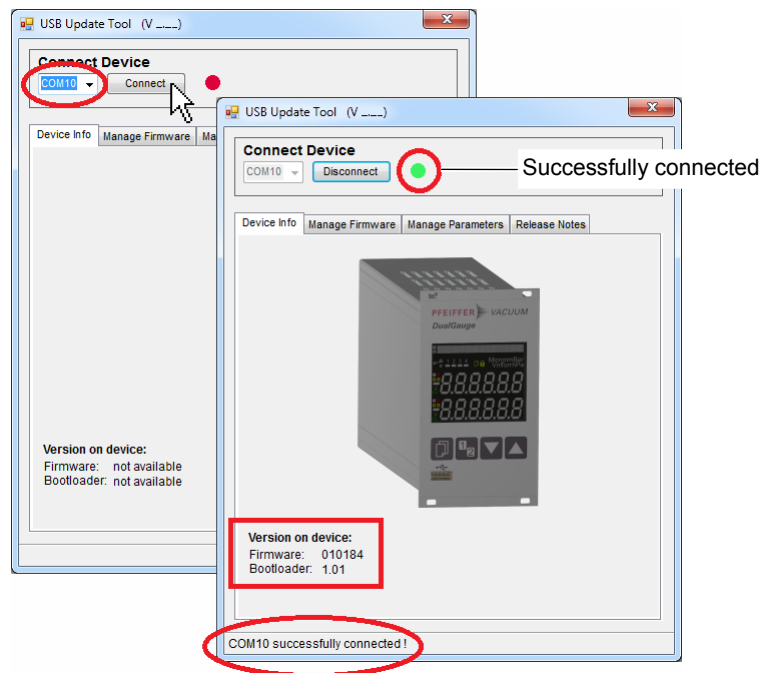

- Click on <Release Notes> to view the software release notes.

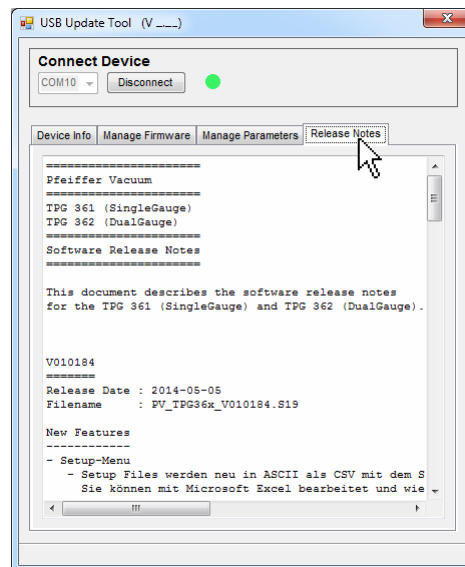

5 Click on <Manage Firmware>, select firmware ...

- Option <Load from disk>: Download a copy of the firmware from our website www.pfeiffer-vacuum.com. Then, select the appropriate folder.
- Option <Load from server>: The update tool connects to the internet. Select the desired firmware version from the selection list.

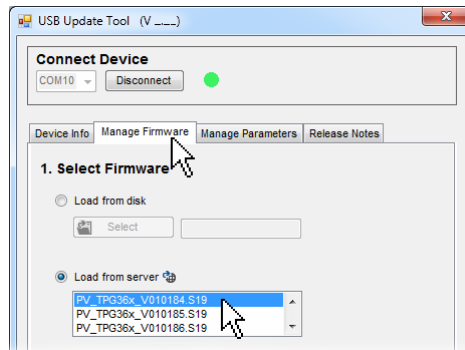

... and click <Update>: The firmware is updated.

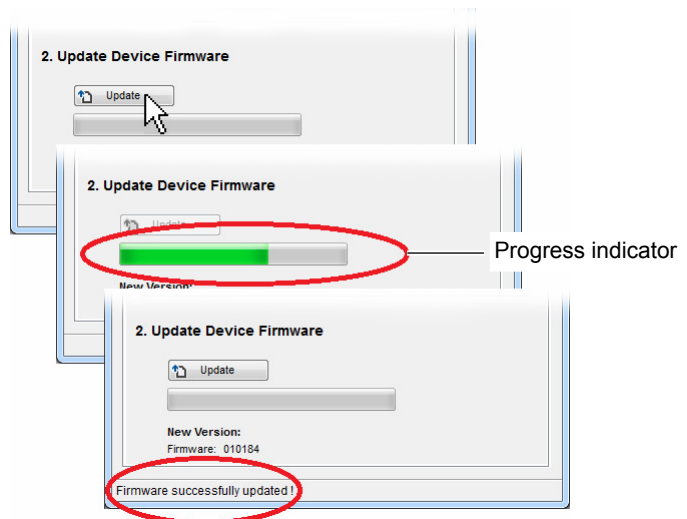

If the update was not successful, try again.

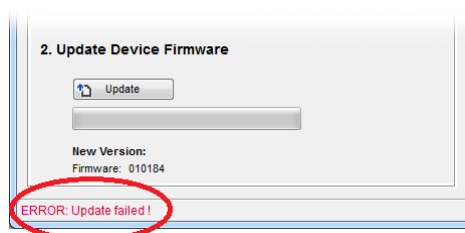

C: Ethernet Configuration

The Ethernet Configuration Tool facilitates configuration of the ethernet interface via a PC. In addition, a virtual serial interface (COM) can be assigned to an IP address.

Via the virtual COM interfaces it is possible to engage with each program that supports serial interfaces (e.g. terminal program, LabView, etc.). Depending on the protocol setting (→ 43), communication with the unit occurs with the Mnemonic or Pfeiffer Vacuum Protocol.

Precondition: Windows 7 or 8 operating system (does not work under Windows XP)

- 1 Download the Ethernet Configuration Tool from our website "www.pfeiffer-vacuum.com".
- 2 Connect the unit to the PC using an ethernet cable.
- 3 Start the Ethernet Configuration Tool and click on <Search Devices>: the Tool searches the local network for connected devices and lists the devices thus found in the selection window. The <Device Info> register shows basic information about the selected device.

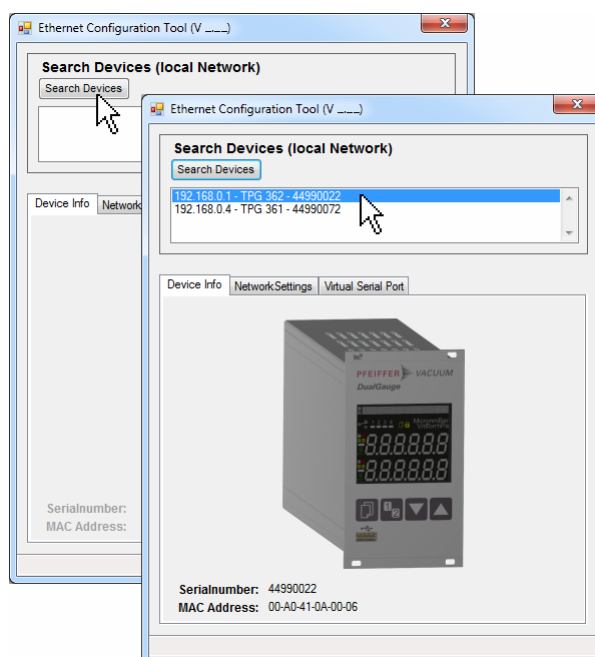

- 4 Automatic or manual network setting occurs in the <Network Settings> register.

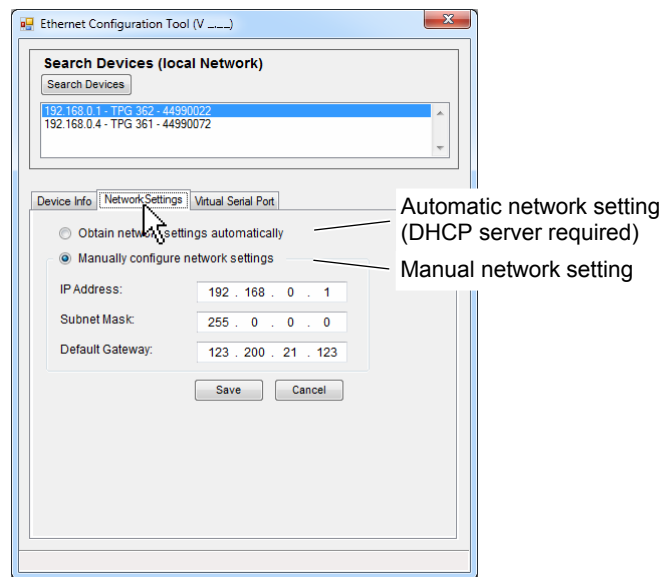



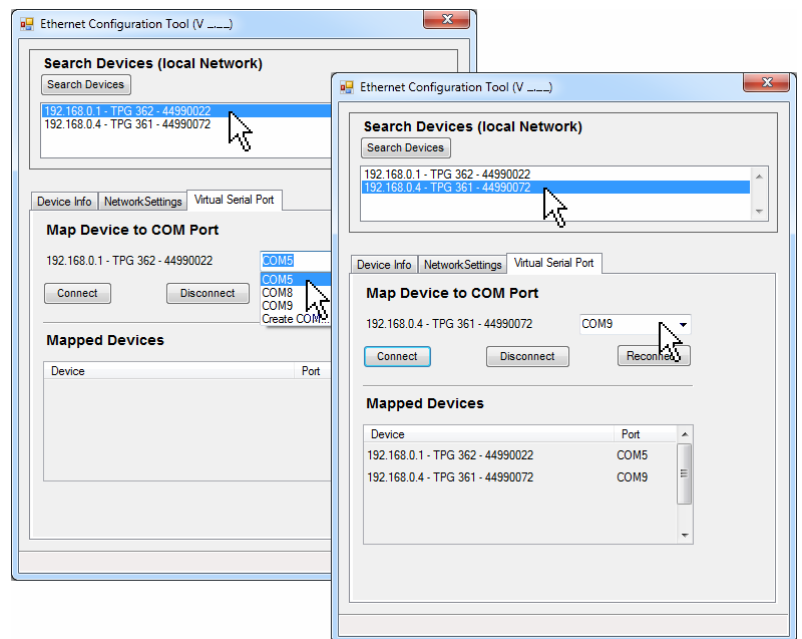



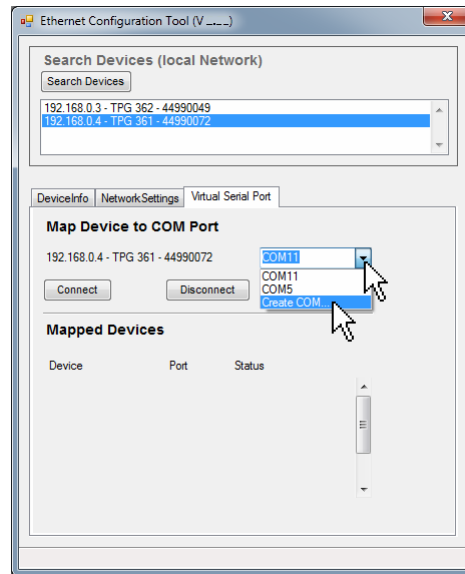

- 5 In the <Virtual Serial Port> register a specific COM Port can be assigned to each device, and/or ...



... a new COM Port can be created.



D: Literature

-  [1] www.pfeiffer-vacuum.com
 Instruction Sheet
 Compact Pirani Gauge TPR 261
 BG 5105 BEN
 Pfeiffer Vacuum GmbH, D-35614 Asslar, Germany
-  [2] www.pfeiffer-vacuum.com
 Instruction Sheet
 Compact Pirani Gauge TPR 265
 BG 5177 BEN
 Pfeiffer Vacuum GmbH, D-35614 Asslar, Germany
-  [3] www.pfeiffer-vacuum.com
 Operating Instructions
 Compact Pirani Gauge TPR 280, TPR 281
 BG 5178 BEN
 Pfeiffer Vacuum GmbH, D-35614 Asslar, Germany
-  [4] www.pfeiffer-vacuum.com
 Operating Instructions
 Compact Pirani Capacitance Gauge PCR 260
 BG 5180 BEN
 Pfeiffer Vacuum GmbH, D-35614 Asslar, Germany
-  [5] www.pfeiffer-vacuum.com
 Operating Instructions
 Compact Pirani Capacitance Gauge PCR 280
 BG 5181 BEN
 Pfeiffer Vacuum GmbH, D-35614 Asslar, Germany
-  [6] www.pfeiffer-vacuum.com
 Operating Instructions
 Compact Pirani Capacitance Gauge PCR 280
 BG 5182 BEN
 Pfeiffer Vacuum GmbH, D-35614 Asslar, Germany
-  [7] www.pfeiffer-vacuum.com
 Instruction Sheet
 Compact Cold Cathode Gauge IKR 251
 BG 5110 BN
 Pfeiffer Vacuum GmbH, D-35614 Asslar, Germany
-  [8] www.pfeiffer-vacuum.com
 Instruction Sheet
 Compact Cold Cathode Gauge IKR 261
 BG 5113 BN
 Pfeiffer Vacuum GmbH, D-35614 Asslar, Germany

- [9] www.pfeiffer-vacuum.com
Instruction Sheet
Compact Cold Cathode Gauge IKR 270
BG 5115 BEN
Pfeiffer Vacuum GmbH, D–35614 Asslar, Germany
- [10] www.pfeiffer-vacuum.com
Operating Instructions
Compact Cold Cathode Gauge IKR 360, IKR 361
Compact FullRange® Gauge PKR 360, PKR 361
BG 5164 BEN
Pfeiffer Vacuum GmbH, D–35614 Asslar, Germany
- [11] www.pfeiffer-vacuum.com
Instruction Sheet
Compact FullRange® Gauge PKR 251
BG 5119 BN
Pfeiffer Vacuum GmbH D–35614 Asslar, Germany
- [12] www.pfeiffer-vacuum.com
Instruction Sheet
Compact FullRange® Gauge PKR 261
BG 5122 BN
Pfeiffer Vacuum GmbH, D–35614 Asslar, Germany
- [13] www.pfeiffer-vacuum.com
Instruction Sheet
Compact Process Ion Gauge IMR 265
BG 5132 BEN
Pfeiffer Vacuum GmbH, D–35614 Asslar, Germany
- [14] www.pfeiffer-vacuum.com
Instruction Sheet
Compact FullRange® BA Gauge PBR 260
BG 5131 BEN
Pfeiffer Vacuum GmbH, D–35614 Asslar, Germany
- [15] www.pfeiffer-vacuum.com
Instruction Sheet
Compact Capacitance Gauge CMR 261 ... CMR 275
BG 5133 BEN
Pfeiffer Vacuum GmbH, D–35614 Asslar, Germany
- [16] www.pfeiffer-vacuum.com
Operating Instructions
Compact Capacitance Gauge CMR 361 ... CMR 365
BG 5136 BEN
Pfeiffer Vacuum GmbH, D–35614 Asslar, Germany
- [17] www.pfeiffer-vacuum.com
Operating Instructions
Compact Capacitance Gauge CMR 371 ... CMR 375
BG 5138 BEN
Pfeiffer Vacuum GmbH, D–35614 Asslar, Germany
- [18] www.pfeiffer-vacuum.com
Instruction Sheet
Compact Piezo Gauge APR 250 ... APR 267
BG 5127 BN
Pfeiffer Vacuum GmbH, D–35614 Asslar, Germany
- [19] www.pfeiffer-vacuum.com
Communication Protocol
RS485 Interface
BG 5510 BEN
Pfeiffer Vacuum GmbH, D–35614 Asslar, Germany

ETL Certification



ETL LISTED

The products TPG 361 and TPG 362

- conform to the UL Standards UL 61010-1 and UL 61010-2-030
- are certified to the CAN/CSA Standards C22.2 No. 61010-1-12 and C22.2 No. 61010-2-030

EC Declaration of Conformity



We, Pfeiffer Vacuum, hereby declare that the equipment mentioned below complies with the provisions of the Directive relating to electrical equipment designed for use within certain voltage limits 2006/95/EC, the Directive relating to electromagnetic compatibility 2004/108/EC and the Directive on the restriction of the use of certain hazardous substances in electrical and electronic equipment 2011/65/EU.

Product

Single- and Dual-Channel Measurement and Control Unit
TPG 361, TPG 362

Part numbers

PT G28 040
PT G28 290

Standards

Harmonized and international/national standards and specifications:

- EN 61000-3-2:2006 + A1:2009 + A2:2009
(EMC: limits for harmonic current emissions)
- EN 61000-3-3:2013
(EMC: limitation of voltage changes, voltage fluctuations and flicker)
- EN 61000-6-1:2007
(EMC: generic immunity for residential, commercial and light-industrial environments)
- EN 61000-6-2:2005
(EMC: generic immunity standard for industrial environments)
- EN 61000-6-3:2007 + A1:2011
(EMC: generic emission standard for residential, commercial and light-industrial environments)
- EN 61000-6-4:2007 + A1:2011
(EMC: generic emission standard for industrial environments)
- EN 61010-1:2010
(Safety requirements for electrical equipment for measurement, control and laboratory use)
- EN 61326-1:2013
(EMC requirements for electrical equipment for measurement, control and laboratory use)

Manufacturer / Signatures

Pfeiffer Vacuum GmbH, Berliner Str. 43, D-35614 Asslar

21 August 2014

21 August 2014

Manfred Bender
Managing Director

Dr. Matthias Wiemer
Managing Director

Notes

Notes

**Vacuum solutions
from a single source**

Pfeiffer Vacuum stands for innovative and custom vacuum solutions worldwide, technological perfection, competent advice and reliable service.

**Complete range
of products**

From a single component to complex systems:
We are the only supplier of vacuum technology
that provides a complete product portfolio.

**Competence in
theory and practice**

Benefit from our know-how and our portfolio of training opportunities! We can support you with your plant layout and provide first-class on-site-service worldwide.

**Are you looking for a
perfect vacuum solution?
Please contact us:**

Pfeiffer Vacuum GmbH
Headquarters • Germany
Tel.: +49 (0) 6441 802-0
info@pfeiffer-vacuum.de
www.pfeiffer-vacuum.com

